



# AquaSense®

*For a safer bathroom • Pour une salle de bains sécuritaire • Para un cuarto de baño seguro*

*Shower Spray • Douche à main • Ducha de mano*

**User's Manual**  
**Manuel d'instructions**  
**Manual del usuario**  
**Manuale dell'utente**  
**Gebrauchsanleitung**  
**Gebruiksaanwijzing**

**770-980**



# 1

Check all parts • Vérifiez toutes les pièces • Verifique todas las piezas  
Controllo dei componenti • Überprüfen sie alle teile • Controleer alle onderdelen

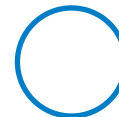
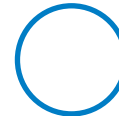
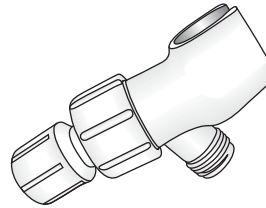
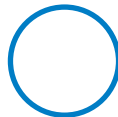
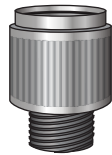
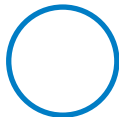
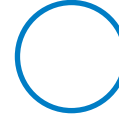
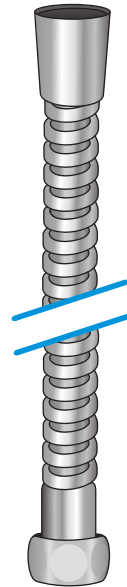
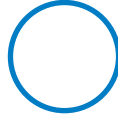
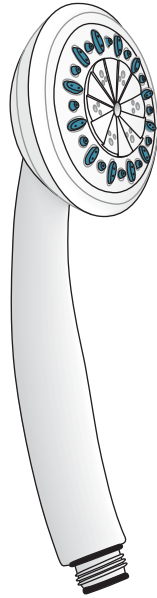
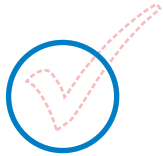

# 2

Setup • Installation • Montaje • Installazione • Vorbereitung • Opstelling

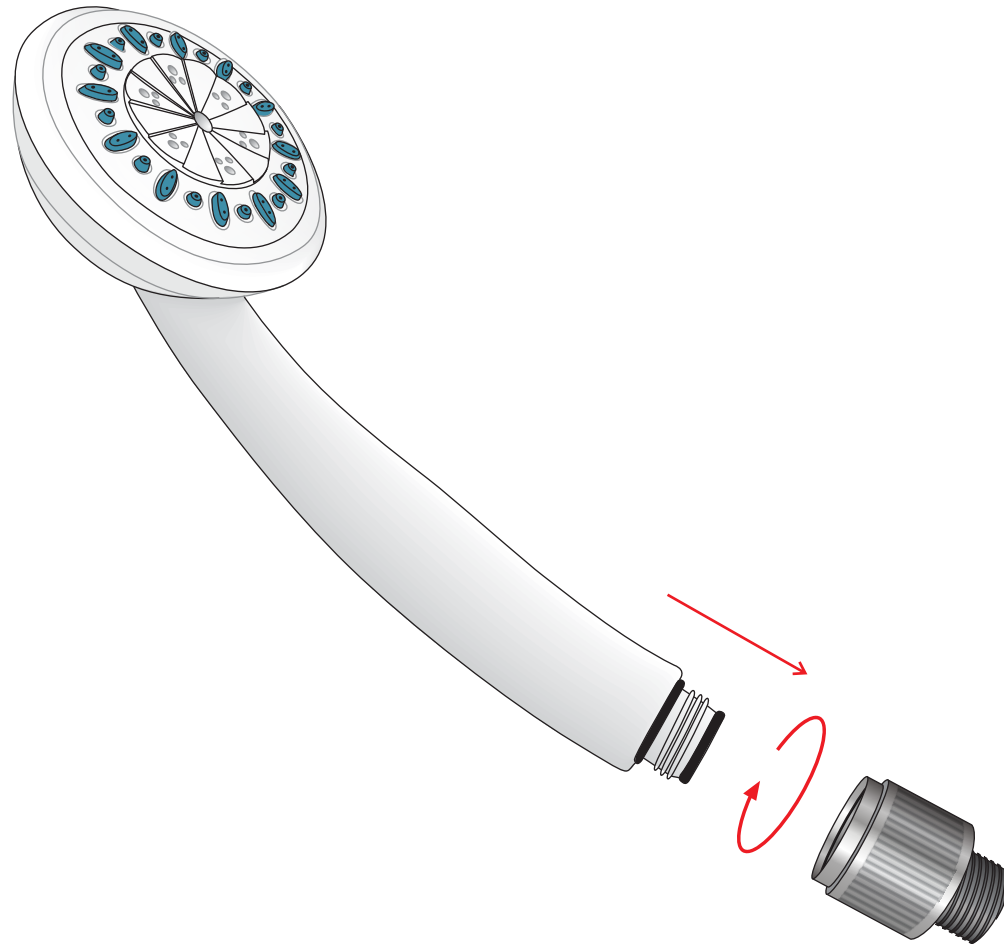
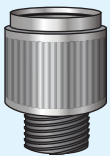
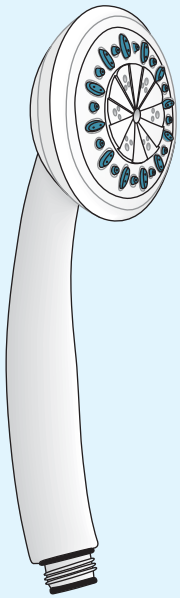

# 3

Setup • Installation • Montaje • Installazione • Vorbereitung • Opstelling

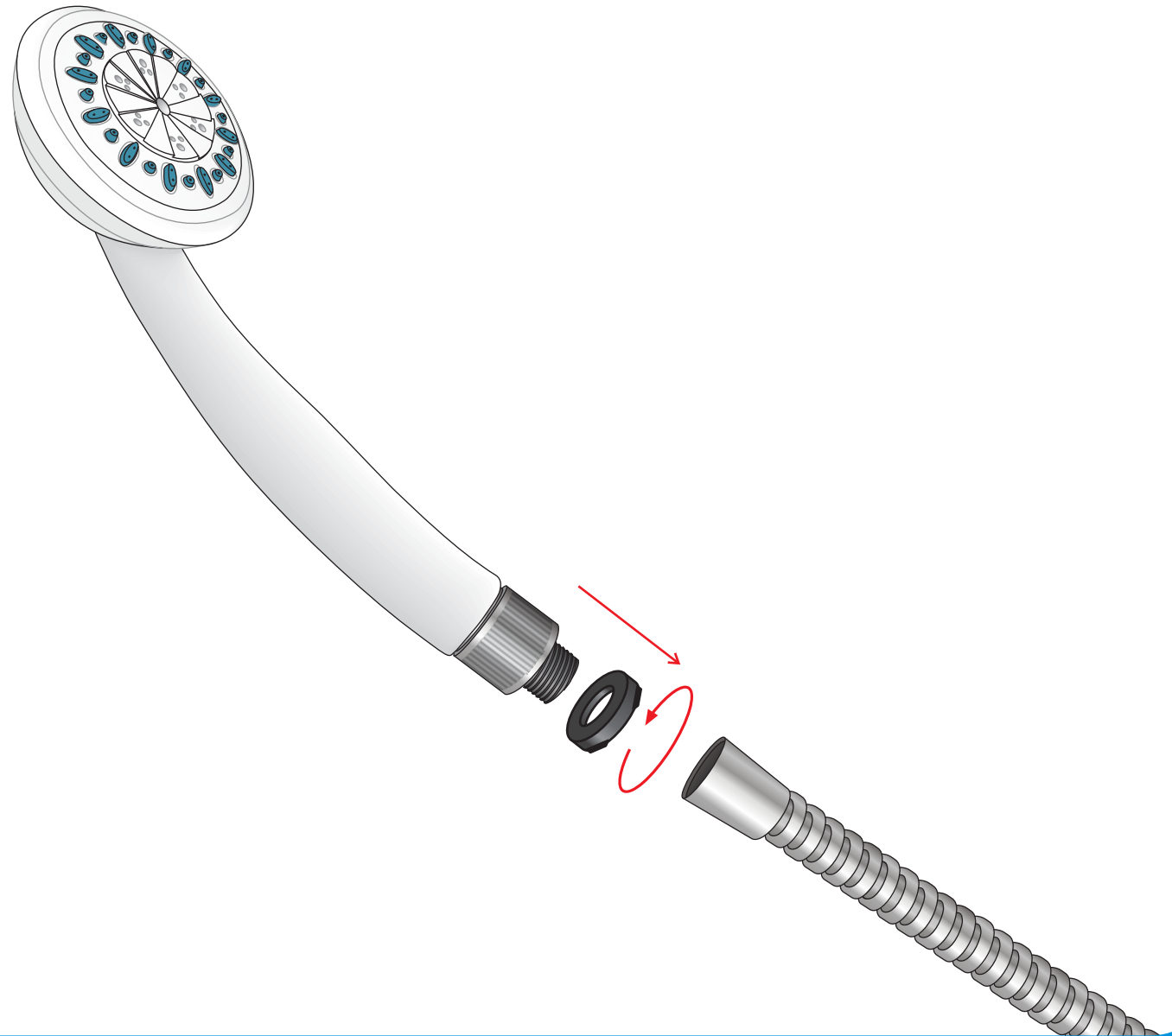
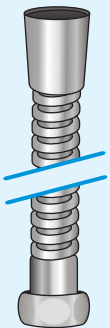
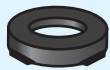
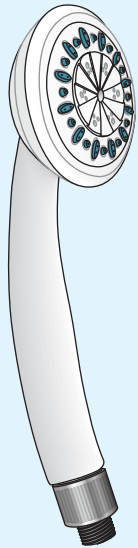

# 4

Setup • Installation • Montaje • Installazione • Vorbereitung • Opstelling

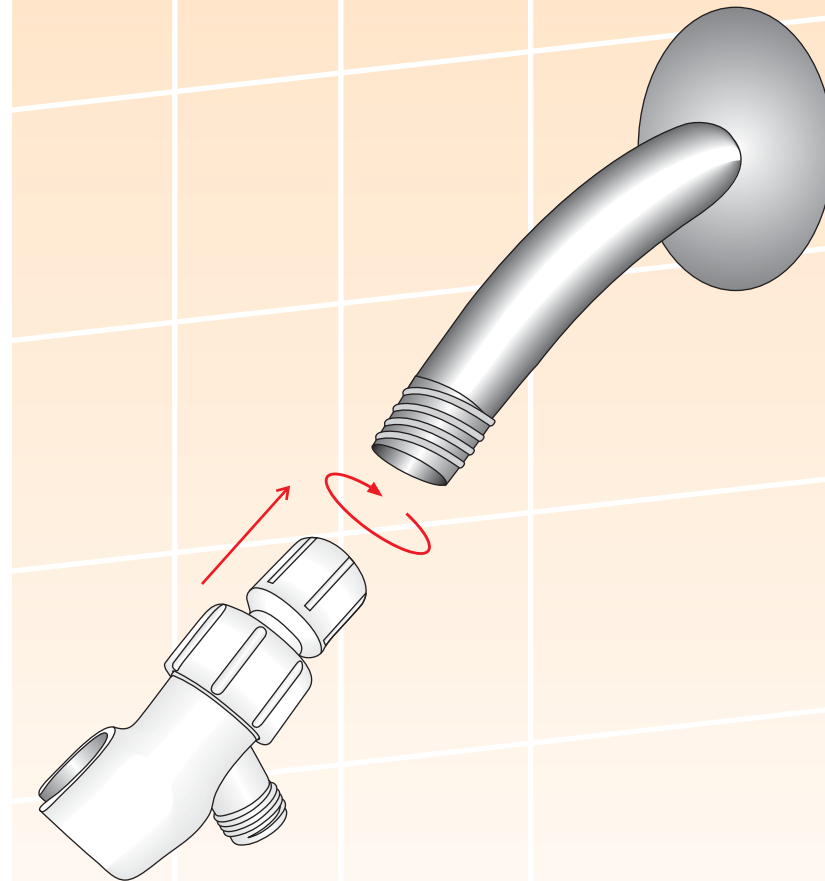
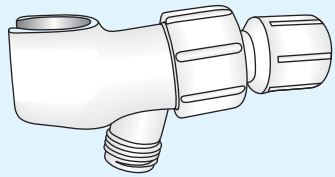

# 5

Setup • Installation • Montaje • Installazione • Vorbereitung • Opstelling

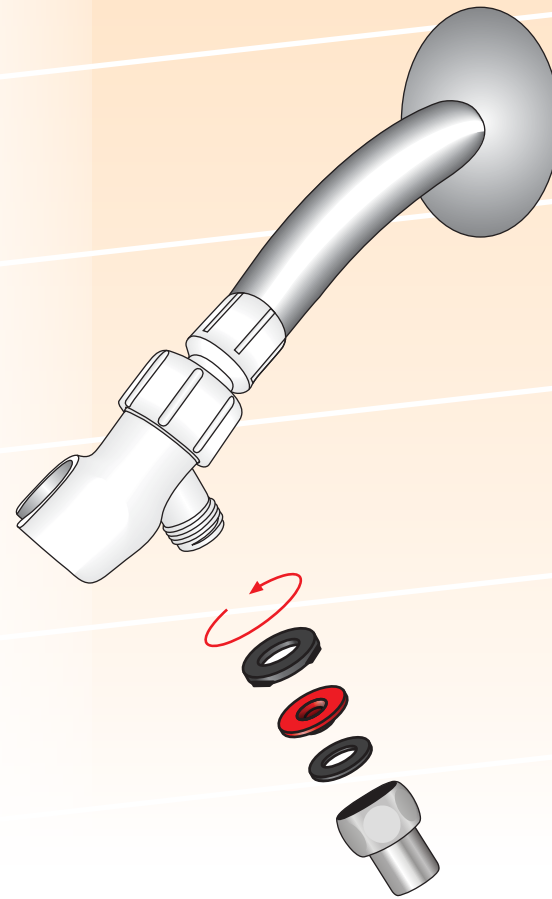
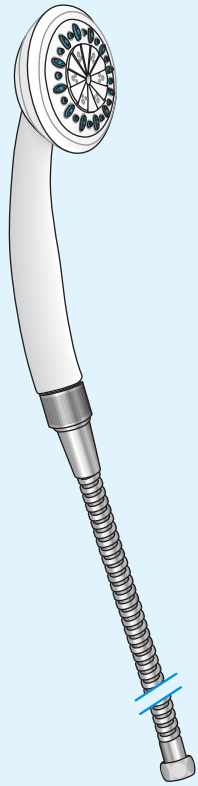

# 6

Setup • Installation • Montaje • Installazione • Vorbereitung • Opstelling



**Two year limited warranty**  
**Garantie limitée de 2 ans**  
**Garantía limitada de dos años**

**EN**

This AquaSense® product is guaranteed to be free from defects in materials and workmanship for two years. This warranty does not extend to non-durable components which are subject to normal wear and replacement. Any alterations, abuse, misuse, or accidental damage voids this warranty. For replacement or repair under warranty, please call:

**CANADA & INTL: 1-800-363-2381** (Monday to Friday, 8 am to 5 pm EST)  
**USA: 1-866-820-2086** (Monday to Friday, 8 am to 5 pm EST)

*For more information on this, or any other AquaSense® product, visit:*  
[www.myAquaSense.com](http://www.myAquaSense.com)

**FR**

Ce produit AquaSense® est garanti deux ans contre toute défectuosité de matériaux ou de fabrication. Cette garantie ne s'applique pas aux composantes non durables, qui sont sujettes à l'usure normale et au remplacement. Toute modification, usage abusif ou impropre, ainsi que les dommages accidentels annulent cette garantie. Pour remplacement ou réparation en vertu de cette garantie, communiquez avec nous au :

**CANADA ET INTL : 1-800-363-2381** (du lundi au vendredi, de 8 h à 17 h HNE)  
**ÉTATS-UNIS : 1-866-820-2086** (du lundi au vendredi, de 8 h à 17 h HNE)

*Pour en savoir plus sur ce produit, ou sur tout autre produit AquaSense®, visitez le* [www.myAquaSense.com](http://www.myAquaSense.com)

**ESP**

Este producto AquaSense® está garantizado contra defectos de materiales y de fabricación por dos años. Esta garantía no cubre los componentes no durables, que están sujetos al desgaste normal y reemplazo. En caso de cualquier alteración, abuso, uso erróneo o daño accidental esta garantía quedará anulada. El alquiler de este producto anula la garantía. Para el reemplazo o la reparación bajo garantía, llame por favor :

**CANADÁ ET INTL : 1-800-363-2381** (de lunes a viernes, de 8 de la mañana a 5 de la tarde, hora normal del Este)  
**E.E.U.U. : 1-866-820-2086** (de lunes a viernes, de 8 de la mañana a 5 de la tarde, hora normal del Este)

*Para más información sobre este u otros productos Aquasense®, visite* [www.myAquaSense.com](http://www.myAquaSense.com)

**Garanzia limitata di due anni**  
**Zweijährige eingeschränkte Gewährleistung**  
**Twee jaar beperkte garantie**

**IT**

Si garantisce che questo prodotto AquaSense® sarà esente da difetti di materiali e lavorazione per due anni. Sono esclusi da questa garanzia i componenti non durevoli, soggetti a normale usura e sostituzione. Eventuali alterazioni, abusi o danni accidentali annullano la garanzia. Il noleggio di questo prodotto annulla la garanzia. Per la sostituzione o riparazioni nell'ambito di validità della garanzia, chiamare:

**CANADA E ALTRI PAESI FUORI DEGLI USA: 1-800-363-2381** (da lunedì a venerdì, dalle 08:00 alle 17:00 fuso orario della Costa orientale [GMT – 5 ore])

**USA: 1-866-820-2086** (da lunedì a venerdì, dalle 08:00 alle 17:00 fuso orario della Costa orientale [GMT – 5 ore])

**DE**

Für dieses AquaSense®-Produkt besteht eine zweijährige Garantie auf die Fehlerfreiheit von Material und Verarbeitung. Diese Gewährleistung erstreckt sich nicht auf Verschleißteile, die einer normalen Abnutzung unterliegen. Vorgenommene Veränderungen, unsachgemäße oder missbräuchliche Verwendung sowie versehentliche Beschädigungen sind von dieser Gewährleistung ausgenommen. Bei Vermietung dieses Produkts verfällt die Gewährleistung. Telefonnummer für Kundenservice-Anfragen und Garantiefälle:

**KANADA & INTERNATIONAL: 1-800-363-2381** (Montag bis Freitag, 14-23 Uhr)

**USA: 1-866-820-2086** (Montag bis Freitag, 14-23 Uhr)

**NL**

Dit AquaSense®-product is gedurende twee jaar gegarandeerd vrij van materiaal- en fabricagefouten. Deze garantie strekt zich niet uit tot niet-duurzame bestanddelen die aan normale slijtage en vervanging onderhevig zijn. Alle aanpassingen, misbruik, verkeerd gebruik of ongelukken die schade kunnen veroorzaken maken deze garantie ongeldig. Verhuur van dit product maakt de garantie ongeldig. Bel voor vervanging of herstel krachtens de garantie:

**CANADA & INTL: 1-800-363-2381** (maandag tot vrijdag, 8.00 tot 17.00 uur EST)

**VS 1-866-820-2086** (maandag tot vrijdag, 8.00 tot 17.00 uur EST)