

LOOP SLINGS

INSTRUCTION FOR USE



CE

Design Policy and Copyright

® and ™ are trademarks belonging to the ArjoHuntleigh group of companies.

© ArjoHuntleigh 2012.

As our policy is one of continuous improvement, we reserve the right to modify designs without prior notice.

The content of this publication may not be copied either whole or in part without the consent of ArjoHuntleigh.

Table of Contents

General Information	4
Resident/Patient Handling Guidelines	4
Sling Warranty	4
Manufacturer Information.....	4
Safe Working Loads.....	4
Sling Safety Inspection and Care.....	4
How to Conduct a Visual Inspection	5
Laundering Instructions.....	5
Monthly Visual Safety Inspection Record	6
Monthly Visual Safety Inspection Record	6
Important Notice.....	6
Sling Fit	7
Sling Material	7
To Fit a Sling on a Person Laying on the Floor or in a Bed :	7
To Fit a sling on a Seated Position Person.....	8
Waist Size	8
Thighs Size	8
Choosing the Proper Loops	8
Lifting a Resident/Patient	10
Lifting from a Seated Position	10
Lifting from a Bed	13
Lifting from the Floor	16
Limb Sling	18
Hammock and Hammock 6 Slings	20
Hygienic Sling	23
Quick Fit Sling	25
Band Sling and Chest Harness	27
Total Transfer Harness	29
Combi Sling	31
Repositioning Sling	33
Morgue Transfer Device	35
Walking Sling	37

General Information

Resident/Patient Handling Guidelines

We receive many inquiries regarding correct resident/patient handling policies and the number of staff that should assist when transferring residents/patients. There are many factors that contribute to making an informed decision that results in safe handling and transferring of residents/patients using patient handling devices.

While our patient lifts are designed to be operated by a single caregiver, we strongly recommend that two attendants be present, particularly with difficult residents/patients, to ensure a safe transfer.

Our lifts are designed for transfers over the shortest possible distance. Although many facilities deem patient lifts appropriate for transporting residents/patients, we recommend for reasons such as patient dignity that the transport of residents/patients be limited. Of course the final decision is that of the facility assessment team. It is the responsibility of each facility, not ArjoHuntleigh, to establish their own resident/patient handling policies, procedures and protocols.

In our opinion, this would include written assessment and reassessment procedures that are developed by a team that may include the Nursing Director and/or appropriate nursing staff and assistants, Physical therapist, Physicians, Facility Safety Committee and/or Risk Manager and Administration.

This team decides resident/patient handling protocols along with the appropriate resident/patient handling device. ArjoHuntleigh therefore accepts no responsibilities or claims regarding a facility application of a lifting device or lifting accessory.

We can provide guidelines to assist the individual facility in establishing their own specific resident/patient handling protocols and provide information on the assessment process. ArjoHuntleigh provides a wide variety of resident/patient lifts, some of which are multipurpose while others perform a dedicated task.

Sling Warranty

ArjoHuntleigh warranties all washable models of our resident/patient lifting slings loop for one year against manufacturer's defects provided that the slings are used for the purpose intended, washed, dried, maintained and safely checked according to care labels and the visual inspection described in these instructions.

To ensure warranty, the slings must be used only on appropriate ArjoHuntleigh patient lifting devices.

Manufacturer Information

This product was manufactured by:
ArjoHuntleigh AB
Verkstadsvägen 5
241 38 Eslöv
SWEDEN

☎ : +46 (0) 10-335 45 00

📠 : +46 (0) 413-138 76

🌐 : www.ArjoHuntleigh.com

Safe Working Loads

All ArjoHuntleigh slings are manufactured and tested to established ISO standards.

Care should be taken to ensure the lift and the sling selected for the job at hand have the lifting capacity to accomplish the task, since the capacity of the mechanical lift may differ from the capacity of the sling.

Sling Safety Inspection and Care

ArjoHuntleigh slings are especially designed for ceiling lifts, floor lifts and accessories made by ArjoHuntleigh. They are not interchangeable with other manufacturers slings. To ensure safe resident/patient transfers, use only ArjoHuntleigh slings with your ArjoHuntleigh loop-style lift.

Due to the nature of their use it is imperative that a resident/patient transfer sling be inspected prior to each use. A documented monthly inspection program should be established to formally inspect all slings to ensure the safest possible transfer of a resident/patient.

Numerous factors impact the life span of a resident/patient transfer sling and they are so varied that a sling should be taken out of service after 2 years. This 2 years'span is a guideline for the useful life of a sling and, in fact, it may be shorter or longer depending on how the slings condition is affected by the number of washings, washing temperature, detergents, disinfectants, frequency of use, resident/patient weight and/or numerous other factors. Currently there is no method to measure the strength of a sling once it is put into service and has been laundered multiple times, without damaging the sling itself. ArjoHuntleigh sling models are manufactured to the highest standards and under ideal circumstances it will provide many years of service.

With this in mind, ArjoHuntleigh has developed a set of visual guidelines to assess the safety of a sling currently in use. Any visual inspection is a subjective evaluation and therefore can never be considered a guarantee of a sling's safety. It will however dramatically reduce the risk of failure.

General Information

How to Conduct a Visual Inspection

- 1) Lay sling out on a flat surface so that all areas of the sling are visible.
- 2) Check all loops at their connection/stress points. Twist these with your fingers and look for any signs of fraying. See the accompanying diagram of a common sling to assist you in locating loop points and other key areas (see figure below).
- 3) Check the stitching of the entire sling, look for any fraying or loose stitching.
- 4) Check the sling for heat damage. This may be detected as an over all shrinking of the sling or may be noticed on the padded leg section and be identified by a shrinking or scrunching of the leg portion. Additionally, heat damage may be found on other areas by noticing a brittle or ridged/stiff feel to the fabric.
- 5) Check the body of the sling for any rips or holes.
- 6) Check the sling for signs of exposure to bleach. This may be suspected if there is fading of the sling ID labels. Reject any sling laundered with bleach.
- 7) Check the sling for excessive staining. While some staining may occur through use by an incontinent patient other staining may indicate exposure to chemicals.

CAUTION :

If any abnormalities are detected after the sling inspection, or if you have any doubts about the sling safety, as a precaution and to ensure safety, stop using it.

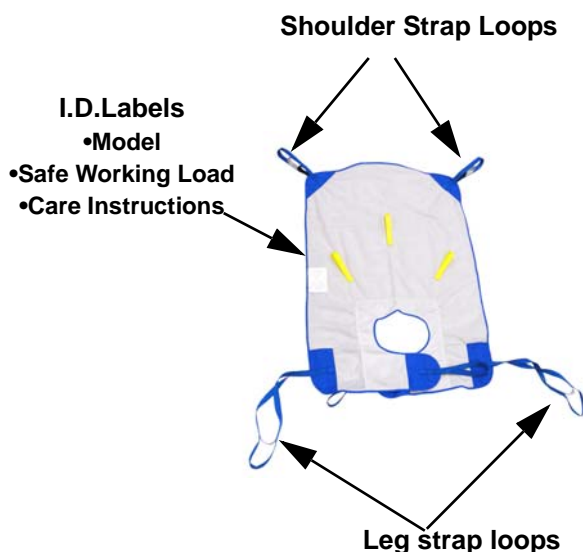

Laundering Instructions

Your laundry staff or service must be made aware of these care instructions as their handling of this sling will have a direct impact on its condition :

- Machine wash in mild soap solution at temperatures below 80°C/176°F.
- Never use bleach.
- Rinse thoroughly.
- No tumble dry.
- Do not place in contact with a heat source.
- Do not dry clean.
- Do not iron.

This care label can be found on all slings manufactured by ArjoHuntleigh.:

ARJOHUNTLEIGH GETINGE GROUP		BAR CODE SN SSMYYBBBBNNNN
REF ARTICLE NUMBER: XXXXXX	SIZE: XXXXXX	BAR CODE LOT SSMYYBBBB
SWL XXX kg (XXX lb)		
ArjoHuntleigh AB Verkstadsvägen 5 241 38 Eslov SWEDEN		Patient's name
Made in China www.ArjoHuntleigh.com		
INSPECT THIS SLING BEFORE EACH USE DO NOT USE IF TORN OR DAMAGED		

Monthly Visual Safety Inspection Record

Monthly Visual Safety Inspection Record

Use this record each time you conduct a safety inspection. Retain this record on file so it can continue to be completed and kept current.

Due to the nature of their use it is imperative that a client transfer sling be inspected prior to each use. A documented monthly inspection program should be established to formally inspect all slings to ensure the safest possible transfer of a resident/patient.

We suggest using the following Inspection Record:

	Inspection Date		Inspected by		Condition Notes	
	Year 1	Year 2	Year 1	Year 2	Year 1	Year 2
January						
February						
March						
April						
May						
June						
July						
August						
September						
October						
November						
December						
Serial Number :				Date the sling was put into service :		
Model Number :						

Important Notice

ArjoHuntleigh's slings are designed to be used only with ArjoHuntleigh resident/patient's loop-style lifts. We will not accept any responsibility for use of a ArjoHuntleigh sling with any other resident/patient's lift or transport equipment designed by another manufacturer.

This sling is designed and manufactured to the highest possible performance standards and is constructed of synthetic fabrics offering durable service when handled according to the stated instructions. Due to the potential exposure to harsh cleaners, disinfectants or other chemicals as well as washing, resident/patient weight, incontinence, etc., ArjoHuntleigh is unable to guarantee the continued integrity of this product under all conditions.

Due to the anthropometric variance in our population, and numerous types of medical conditions and situations, the following are meant as guidelines to assist in determining proper sling fit. Whenever there is a question of appropriate sling style for a specific medical condition, consult a physician or medical professional. ArjoHuntleigh has Clinical Consultants that can assist in sling choice, fit and application and can provide regular in-service training.

Facilities are often concerned with the lifting capacity of a sling. ArjoHuntleigh slings are labelled with a "safe working load".

Sling Material

ArjoHuntleigh slings are made with durable synthetic material types. Both of our solid and mesh synthetic fabric will support identical loads. Care instructions are also similar. Our solid material slings are recommended for general use. Mesh material slings are a good choice when the sling will be left under the resident/patient for an extended period of time, or when bathing.

There are three basic components for proper sling fit:

- Resident/patient height;
- Resident/patient waist size;
- Resident/patient thighs size.

To Fit a Sling on a Person Laying on the Floor or in a Bed :

- 1) Bend both of resident/patient's legs as much as possible while keeping the feet on the bed/floor.
- 2) Using the resident/patient's knees and shoulders, log roll the resident/patient away from the primary caregiver so that the resident/patient is laying on their side supported by the other staff member. If resident/patient is in bed, the bedside rail facing the resident/patient should be locked in "up" position.
- 3) Have the sling folded along the length of the re-sident/patient so that the interior of the sling folds out, and place it against resident/patient's back. Place the apex of the sling's horseshoe at the coccyx of the resident/patient.
- 4) Now determine where the resident/patient's shoulders are located relative to attachment straps. If the resident/patient's shoulders are above the sling shoulder attachment point (where the strap connects to the body of the sling), a larger sling or head support sling is recommended (see Fig. 1).

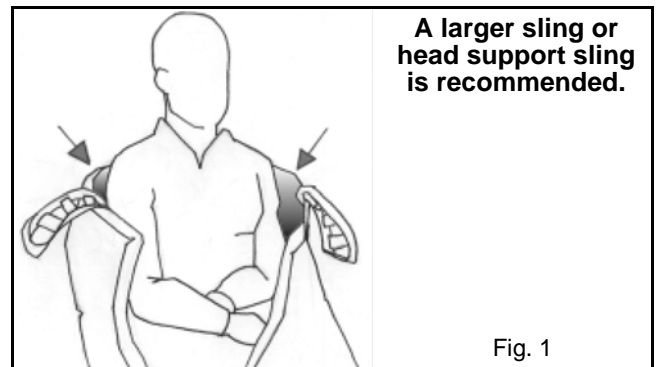

- 5) If however, the resident/patient's shoulders are substantially below the sling shoulder attachment point (where the strap connects to the body of the sling), due to a very small and/or thin resident/patient, then a smaller sling should be considered (see Fig. 2).

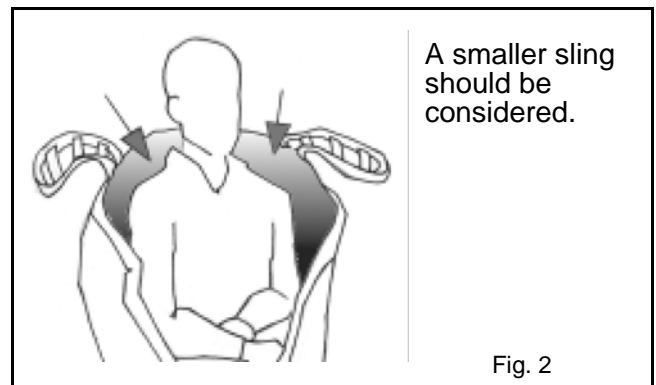

Sling Fit

To Fit a sling on a Seated Position Person

- 1) Hold the apex of the sling's horseshoe where the centre stripe ends and place the sling behind the resident/patient, care labels to the outside, until you are able to touch the seat of the chair and then have the resident/patient lean back against the sling.
- 2) Keeping the apex at the resident/patient's coccyx, pull the remainder of the sling gently upward until the sling is snug. Now determine where the resident/patient's shoulders are located relative to the sling shoulder straps (where strap attaches to the body of the sling.)
- 3) Once the sling is positioned, make sure the attachment points are located relative to the re-sident/patient's shoulders. If the resident/patient's shoulders are above the shoulder sling attachment points, (where the strap attaches to the body of the sling), a larger sling or "head support" sling is recommended (see Fig. 1 on the previous page).
- 4) If however, the resident/patient's shoulders are substantially below the attachment points due to a very small or thin resident/patient, then a smaller size sling should be considered (see Fig. 2 on the previous page).

Waist Size

After determining proper size of the sling, apply the sling around the resident/patient making sure the sling "centre stripe" is centered on the spine.

If the resident/patient's body touches or falls outside the edge ribbing of the sling, change to a larger or a wider customized sling. This will prevent skin abrasions and tears as well as minimize the possibility of a resident/patient falling or rolling out of the side of an undersized sling.

Thighs Size

After properly fitting the waist, place the leg straps around the sides of the hips and legs, then under the thighs and up between the legs.

If the sling has been applied correctly, the resident/patient's thighs should only be in contact with the padded portion of the leg strap.

If however, the narrow ribbing (extension strapping) of the leg portion is exposed to the skin, skin abrasions and tears may appear. Therefore, a modified sling with longer padded leg section may be indicated. This applies to all types of sling with leg straps. Extended padded leg sections are rarely required and are more commonly required for residents/patients with overly large thighs.

Choosing the Proper Loops

Specific lift slings manufactured by ArjoHuntleigh have a colour code applied to the attachment loops. This coding allows the caregiver to quickly match the left side and right side loops of the shoulder straps and leg straps.

For example; loop 2 on the shoulder strap of the right side colour matches to loop 2 of the shoulder strap on the left side. Alternately, loop 2 of the right leg strap colour matches to loop 2 of the left side leg strap.





Colour coding of the sling loops can be used to guide your choice of which loops to use when lifting a resident/patient.

The following chart indicates the residents/patients position based on loop choice. Choose whichever loop combination gives the most comfortable suspension angle for the resident/patient, bearing in mind the residents/patients ability to support themselves.

Using the longest available leg strap loops results in less flexing of the hips. Using shortest available shoulder strap loop creates a more upright sitting position, conversely using the longest shoulder strap loop increases the angle of recline.







SLINGS - THAI, THA6I, TIR, THY model

Resident/patient's position according to colour straps.

	Shoulders	Legs
		
	Black	Blue
	Grey	Blue
	Blue	Blue
	Blue	Grey

SLINGS- 60000 series model

Resident/patient's position according to colour straps.

	Shoulders	Legs
		
	Yellow	White
	Green	White
	White	Black
	White	Orange

Lifting a Resident/Patient

Lifting from a Seated Position

Wheel chair, toilet or chair - ceiling or floor lifts

Step 1 - Install the sling

Proper body mechanics and sound ergonomic positioning should be maintained by the caregiver at all times.

- 1) If lifting from a wheelchair, put the wheelchair's brakes on, not the lift brakes. While standing in front of the resident/patient with the caregiver's leg between the resident/patient's knees (for added stability), lean the resident/patient slightly forward onto attendant's hip or abdomen area for support. Tuck the top part of the horseshoe area of the sling well down behind the resident/patient's back, as close as possible to the coccyx or seat level, making sure the identification label on the sling is on the outside of the resident/patient. The top of the sling should be resting on the resident/patient's shoulders or upper scapular region.
- 2) Ensure that the top centre handle of the sling and the positioning stripe is centered on the resident/patient's back (see Fig. 3). Lean resident/patient's back into chair or wheelchair.

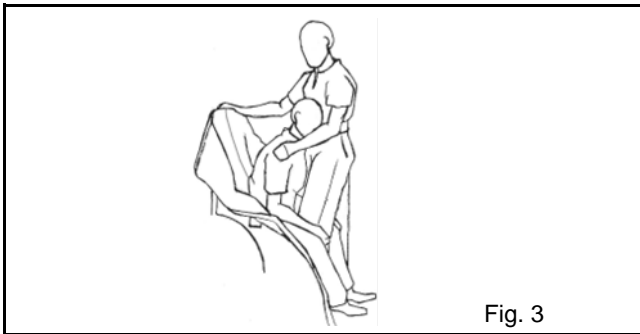

Fig. 3

- 3) From a kneeling/squatting position, the caregiver will gently lift one of the resident/patient's legs apart and fit the leg portion of the sling around the hip and under and up between the legs. When applying the sling around the hips, ensure that the bottom edge of the leg straps is going to fall beneath the trochanters (big bumps on hips). It is the scooping effect under the pelvis that gives stability and safety to the sling, even when residents/patients are resistive and/or moving around in the sling. Loop strap outwards over each leg (see Fig. 4).

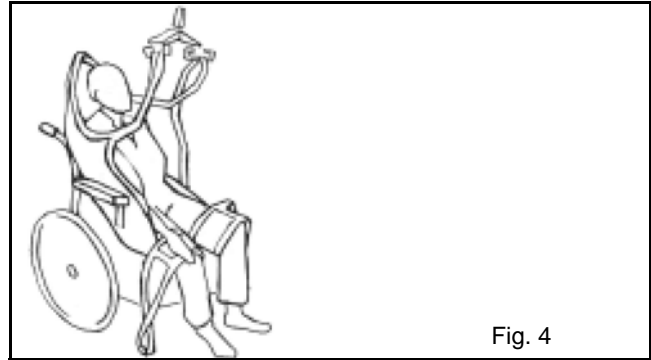
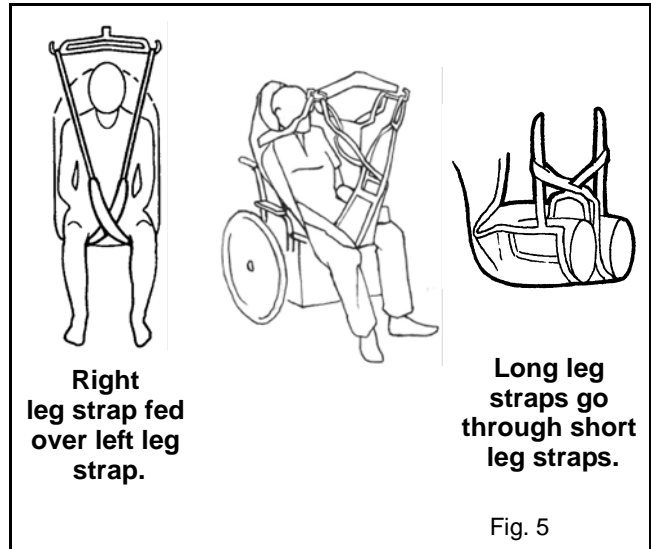

Fig. 4

- 4) Repeat procedure with other leg portion, securing the sling leg portion around the hip, under the leg, and then looping it between the legs.

Option 1 : Conventional "Bridge" type position:

Take leg strap on left of resident/patient, cross it through the right leg strap diagonally in front of resident/patient, and attach it to the right hand spreader bar hook, i.e. to "opposite" hook. Repeat procedure for the right leg strap. The suspended leg straps should now be crossed in front of resident/patient (see Fig. 5).



Right leg strap fed over left leg strap.

Long leg straps go through short leg straps.

Fig. 5

Lifting a Resident/Patient

Option 2 : “Cradle” type position

When a resident/patient is unable to allow for sling straps to fit between the legs, for example a scissored leg resident/patient or a below the knee amputee, use this alternate procedure. Position right leg portion of the sling under both legs and allow it to hang at resident/patient’s left side (See Fig. 6).

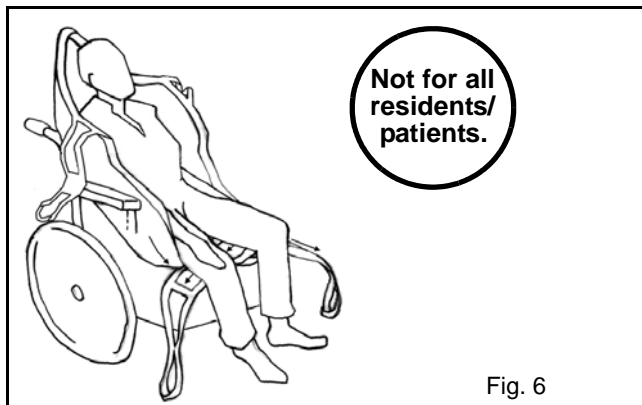

Attach leg straps directly onto the spreader bar. Do not criss-cross (Fig. 7).

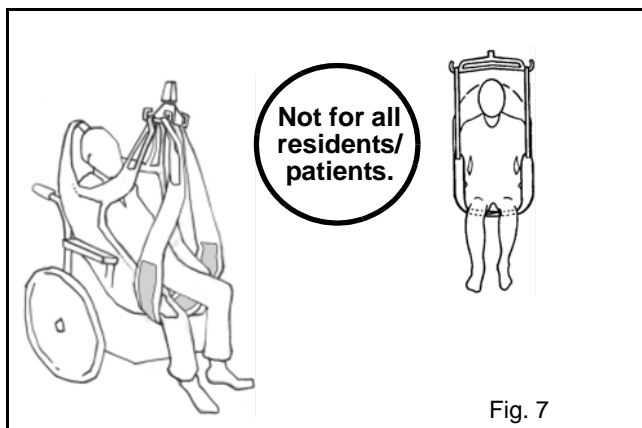

Option 3 : “Legs opened” type position

Use this as an alternative position when the resident/patient is to be transferred to a toilet or requires “peri” care. This type of placement should not be used with fragile or hip replacement residents/patients as it tends to pull the residents/patients legs apart. The stability of this type of sling application is entirely based on the resident/patient’s ability to control hip abduction and/or adduction. If the resident/patient does not have this ability then this type of sling application may not be suitable.

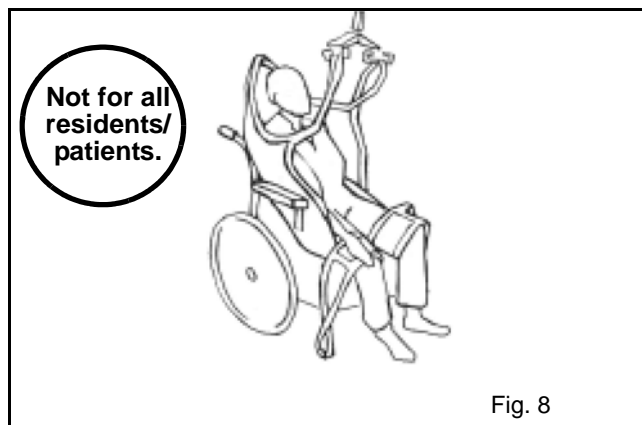

Position leg portion of the sling under each leg and looping it up between the legs. Attach leg straps directly onto the spreader bar. Do not criss-cross (See Fig. 9).

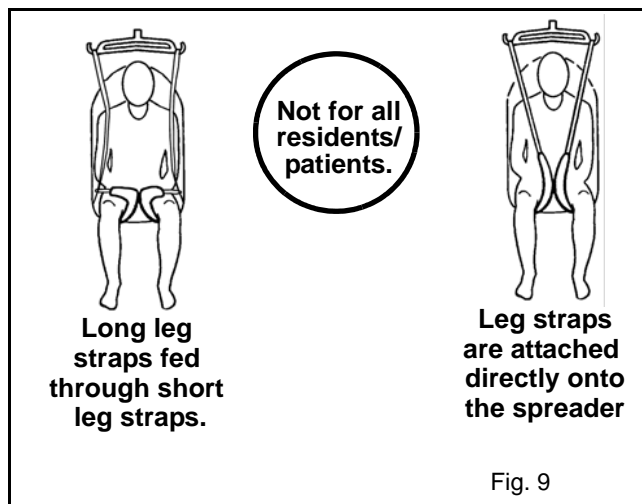

Lifting a Resident/Patient

Step 2 : Lift the resident/patient

- 1) Move lift toward resident/patient. Adjust spreader bar position so that it is parallel to the resident/patient's shoulders and is at a height that the sling can be easily attached.
- 2) Attach right shoulder strap to the right suspension hook on the spreader bar. Repeat with left shoulder strap, using matching loop on left side to ensure the resident/patient will be evenly suspended.
- 3) Make sure the loops of the sling are securely fastened to the spreader bar and fully inside the safety latches.
- 4) The resident/patient can now be lifted using the hand control on the lift. Raise the resident/patient enough to not quite clear the chair. To improve comfort, smooth out any wrinkles under the thighs. Make sure the loops of the sling are securely fastened to the spreader bar.
- 5) Depress the "up" button on the hand control to continue lifting the resident/patient until resident/patient is just comfortably clear of the chair. Pull resident/patient away from the area of the chair using the lift. Lower the resident/patient to the minimum suitable height for transferring. If resident/patient needs steadying while in motion (i.e. uncooperative resident/patient), a second caregiver should use one of the side handles on the sling. If a ceiling lift is used, the caregiver may use both hands to steady the sling during the transfer.

WARNING :

The resident/patient's arms must remain inside the sling at all times to ensure safety.

Step 3 : Lowering to a seated position

- 1) This technique will pay dividends in reducing physical effort. It enables the attendant to avoid the demanding task of post transfer positioning after resident/patient has fully come to rest on the chair. It is a manoeuvre well worth teaching all staff during in-service sessions as it dramatically reduces manual repositioning.
- 2) First, apply wheelchair's brakes, then turn resident/patient's back towards chair. Very slowly lower resident/patient using the remote hand control on lift; the caregiver should be positioned with and behind the resident/patient, steadying resident/patient with one hand on the sling positioning handle.
- 3) Before the resident/patient touches chair seat, and while resident/patient is still moving downward, grasp the sling handle at the mid-line of the resident/patient's back (if not accessible, use handles on the sides of sling). Keep elbow at 90° and grip the centre positioning handle with palm facing up while lowering, and guide the resident/patient into a proper seated position. This manoeuvre when done correctly will not cause shoulder strain (see Fig. 10). The downward motion of the sling will cause the resident/patient to be lowered back into the chair, correctly sitting at a full 90 degrees (instead of sacral sitting) or as close to 90 degrees as physically possible.
- 4) Lower spreader bar just enough to allow unhooking the sling straps. Back the resident/patient lift away from resident/patient. Remove sling by reversing installation procedure.

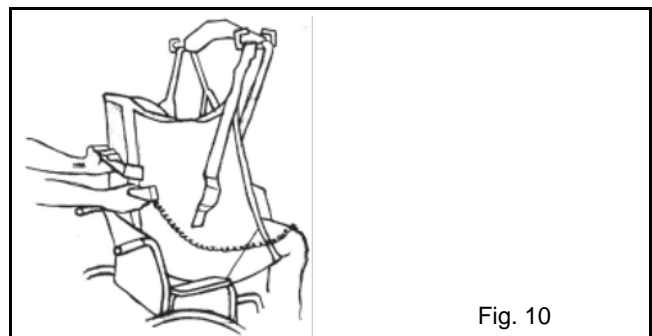

Fig. 10

Lifting a Resident/Patient

Lifting from a Bed

Ceiling or floor lifts

Step 1 - Install the sling

Proper body mechanics and sound ergonomic positioning should be maintained by the caregiver at all times.

Option 1

Lay out sling on bed along side resident/patient with all straps in line with appropriate body part. Log roll resident/patient away from sling. As with all "log roll" procedures, rails on the side of the bed the resident/patient is facing should be in the "up" position.

Place one half of the sling, using two full-length folds, as far under resident/patient's body as possible (See Fig. 11). Bunch just enough material to ensure that when resident/patient is rolled onto his/her back, the spine is centred on the centre line of the sling. The horseshoe shaped cutout should be as close as possible to the coccyx and the centre sling handle should be near the scapular area. Lower the first side-rail and raise the opposite. Roll the resident/patient towards the attendant ("up" side rail) and onto the sling. Pull sling through halfway and free all straps ready for hook up to resident/patient lift. Allow resident/patient to roll fully onto his/her back. Lower side rail.

Option 2

Lay out sling on bed alongside resident/patient with all straps in line with appropriate body part. Log roll resident/patient away from sling. As with all "log roll" procedures, rails on the side of the bed the resident/patient is facing should be in the "up" position.

Fold sling in half, lengthwise, with the side that rests against the resident/patient facing out. Fold the sling a second time by grasping the leg strap and shoulder strap on the side away from your body. With one hand at the apex of the horseshoe, place it at the coccyx. With the centre folded placed at the spine (centre of the back), pull the top of the sling closest to you over the resident/patient and roll them onto their back, checking that the sling is properly placed as you do so. Log roll in the opposite direction and pull folded portion of the sling through.

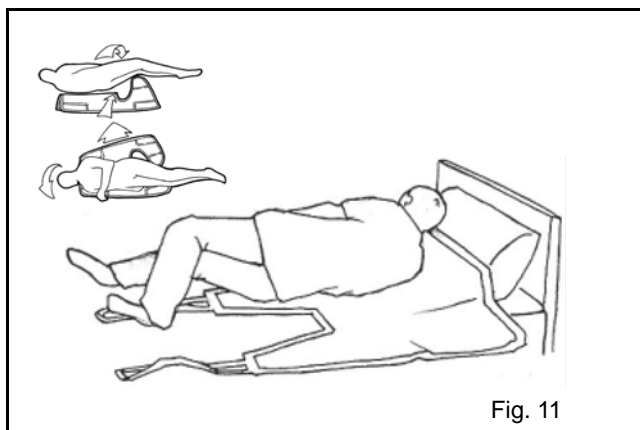

Option 3

When the resident/patient is cooperative and able to assist the caregiver, the following alternate procedure can be used. Raise the head of the bed placing the resident/patient in a seated type position.

Lean resident/patient slightly forward supporting their upper body if necessary. Tuck the top part of the horseshoe area of the sling well down behind the resident/patient's back, as close as possible to the coccyx or seat level, making sure the identification label on the sling is on the outside of the resident/patient. The top of the sling should be resting on the resident/patient's shoulders or upper scapular region (See Fig. 12).

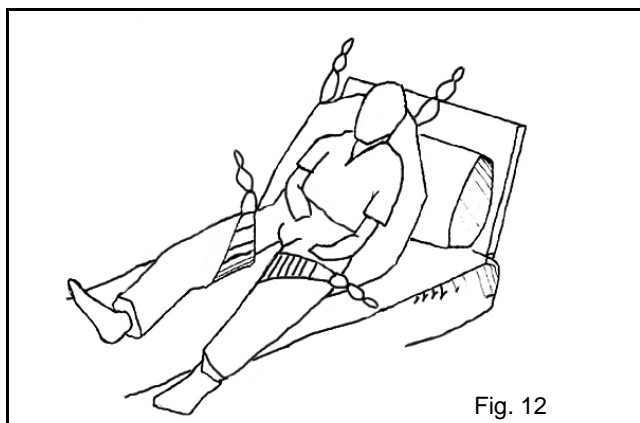

Lifting a Resident/Patient

Options 1, 2 and 3

Finish installing the sling by gently lifting the resident/patient's right leg (bend knee slightly if possible) and pull right leg strap from beside the resident/patient around the hip and up between the legs. When applying the sling around the hips, ensure that the bottom edge of the leg straps is going to fall beneath the trochanters (big bumps on hips). It is the scooping effect under the pelvis that gives stability and safety to the sling, even when residents/patients are resistive and/or moving around in the sling. Loop strap outwards under each resident/patient's leg (See Fig. 13).

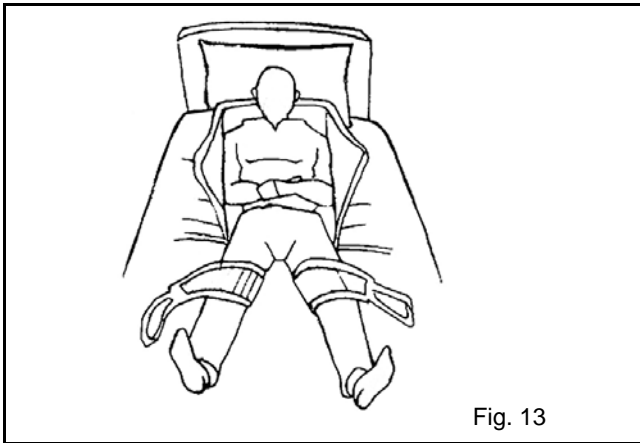
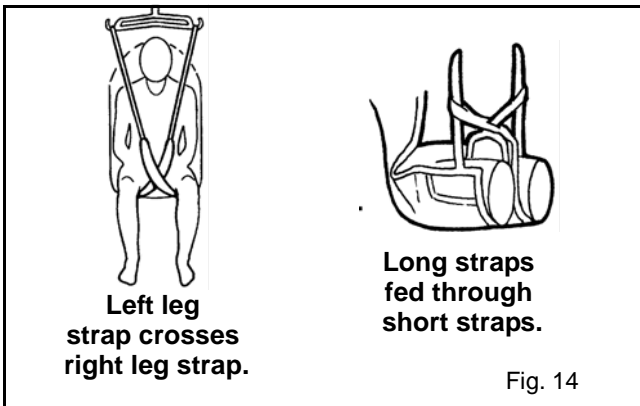

Fig. 13

Conventional "Bridge" type adjustment

Take leg strap on left of resident/patient, cross it through the right leg strap diagonally in front of resident/patient, and attach it to the right hand suspender hook, i.e. to "opposite" hook. Repeat procedure for the right leg strap. The suspended leg straps should now be crossed in front of resident/patient (See Fig. 14).



Left leg strap crosses right leg strap.

Long straps fed through short straps.

Fig. 14

"Legs opened" type adjustment

Use this as an alternative placement when the resident/patient is to be transferred to a toilet or requires "peri" care. This type of placement should not be used with fragile or hip replacement residents/patients as it tends to pull the residents/patients legs apart. The stability of this type of sling application is entirely based on the resident/patient's ability to control hip abduction and/or adduction. If the resident/patient does not have this ability then this type of sling application may not be suitable.

Position leg portion of the sling under each leg and looping it up between the legs. Attach leg straps directly onto the spreader bar. Do not criss-cross (See Fig. 15).

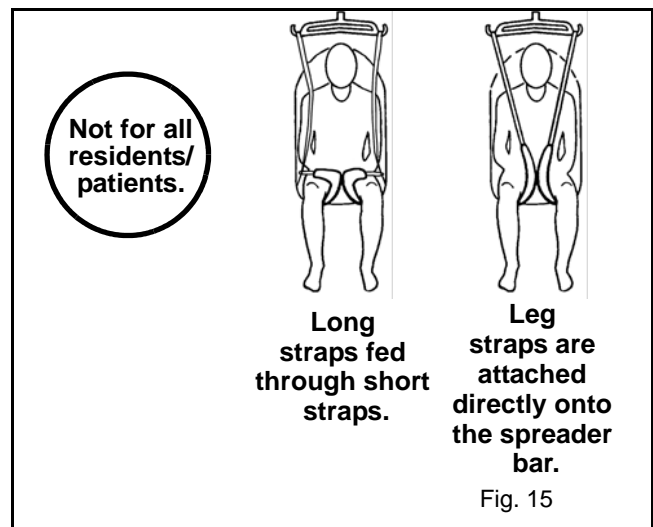

Long straps fed through short straps.

Leg straps are attached directly onto the spreader bar.

Fig. 15

Lifting a Resident/Patient

Option 4

- 1) This option can be used when resident/patient cannot be transferred using the positions shown previously since the resident/patient is unable to allow for sling straps between legs, for example a scissored resident/patient.
- 2) Lay out sling on bed alongside resident/patient with all straps in line with appropriate body part. Log roll resident/patient away from sling. As with all "log roll" procedures, rail on the side of the bed the resident/patient is facing should be in the "up" position.
- 3) Fold sling in half, lengthwise, with the side that rests against the resident/patient facing out. Fold the sling a second time by grasping the leg strap and shoulder strap on the side away from your body. With one hand at the apex of the horseshoe, place it at the coccyx. With the centre fold placed at the spine (centre of the back), pull the top of the sling closest to you over the resident/patient and roll them onto their back, checking that the sling is properly placed as you do so. Log roll in the opposite direction and pull folded portion of the sling through.
- 4) Pull right leg portion of sling under both legs, and lay it at resident/patient's left side. Repeat with left leg portion of the sling, laying it at resident/patient's right side. The sling is crossed under the resident/patient's backside (See Fig. 16). Smooth out any "bunching" under legs.

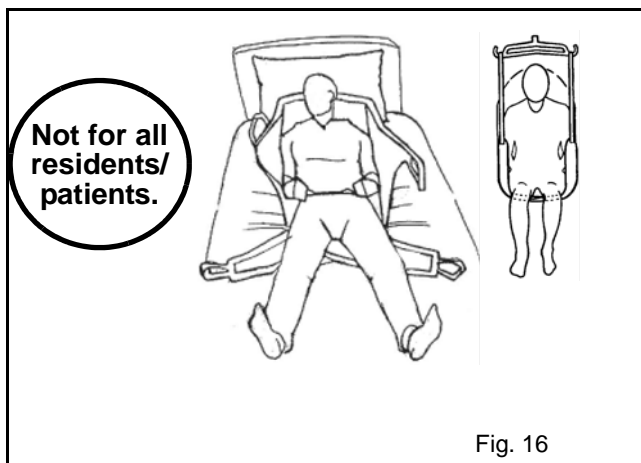

Step 2 : Lift the resident/patient

Floor lifts only

- 1) Ensure lift base is closed. Adjust boom to a suitable height, and then push lift base under side of bed so that the spreader bar can be turned at right angles to resident/patient (floor lift only).
- 2) Adjust spreader bar so it is just over resident/patient's chest area and allows easy hook up of the sling straps. Attach right shoulder strap to the right suspension hook on the spreader bar. Repeat with left shoulder strap, using matching loop on left side to ensure the resident/patient will be evenly suspended.
- 3) The resident/patient's arms remain inside the sling at all times.
- 4) Make sure the loops of the sling are safely fastened to the spreader bar and fully inside the safety latches.
- 5) Raise resident/patient until just clear of bed. Lift each leg, pulling bottom edge of sling fully under the thigh but not in contact with the area behind the knee to improve comfort.
- 6) Double check to make sure that the sling straps are secured in the hooks of the spreader bar of the lift. Continue lifting until mattress surface can be comfortably cleared (See Fig. 17).

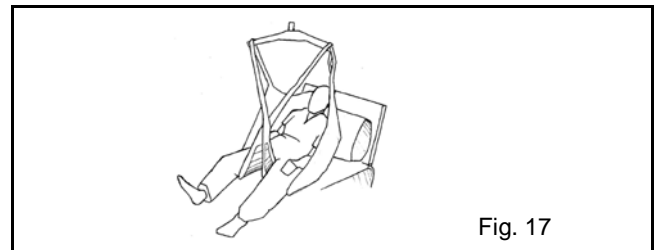

- 7) Pull lift away from bed. Lower lift (and resident/patient) to a suitable minimum height for transferring. The resident/patient should not be pushed/pulled by the sling handles. Pulling the resident/patient with sling handles could result in moving resident/patient's weight outside the lift base and tipping the lift, especially in the high position.

Lifting a Resident/Patient

Step 3 - Lowering onto a bed

Raise or lower lift until resident/patient is just high enough to clear bed. Rotate resident/patient into correct position so that head will rest on pillow when lowered. Push lift base under side of bed and into a suitable position for lowering resident/patient onto bed at right angle to bed (floor lift only).

Operate lift control to slowly and gently lower resident/patient onto bed, steadying resident/patient if necessary. Continue to lower until resident/patient is supported on bed. Disconnect sling straps from spreader bar hooks on the lift.

Lifting from the Floor

Floor lifts

Residents/patients being lifted from the floor are normally in this position due to a slip or fall. These residents/patients should only be lifted after examination by qualified medical personnel.

Step 1 - Install the sling

Proper body mechanics and sound ergonomic positioning should be maintained by the caregiver at all times.

Option 1

- 1) Lay out sling on the floor alongside resident/patient with all straps in line with appropriate body part. Log roll resident/patient away from the sling.
- 2) Fold sling in half, lengthwise, with the side that rests against the resident/patient facing out. Fold the upper half of the sling a second time by grasping the leg strap and shoulder strap on the side away from your body. With one hand at the apex of the horseshoe, place it at the coccyx. Push the sling as far under resident/patient's body as possible. Bunch just enough material to ensure that when resident/patient is rolled back, the spine is aligned on the center of the sling.
- 3) The horseshoe shaped cutout should be as close as possible to the coccyx area and centre sling handle should be near the scapular area.
- 4) Roll the resident/patient towards the attendant. Pull sling through halfway and free all straps ready for hook up to resident/patient lift. Allow resident/patient to roll fully onto his/her back.
- 5) Gently lift resident/patient's right leg and pull the right leg strap from behind, alongside the resident/patient, under the right thigh and up between the legs. Loop strap over resident/patient's right leg. Repeat procedure with left leg.

Option 2

- 1) When resident/patient is unable to allow for sling straps between legs, for example, a scissored re-sident/patient, repeat steps from option 1 procedure, except for the last paragraph.
- 2) Pull right leg strap under both legs, and lay it as resident/patient's left side. Repeat with left leg strap, laying it at resident/patient's right side. The sling is then crossed under resident/patient's back. (see Fig. 18). Smooth out any "bunching" under the legs.

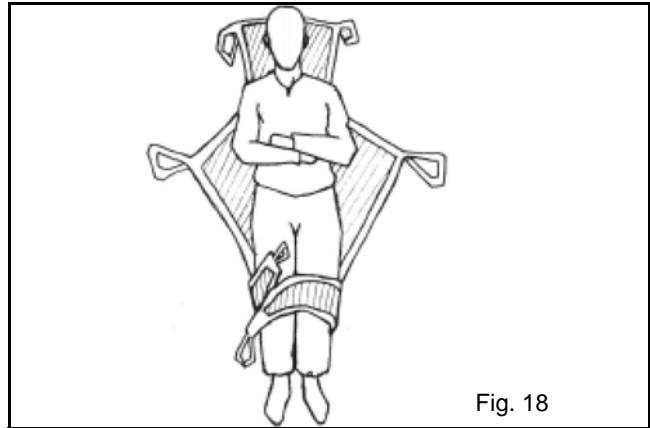

Fig. 18

Lifting a Resident/Patient

Step 2 : Lift the resident/patient

- 1) Bring lift to a position close to resident/patient's feet and in line with the resident/patient's body, with the lift boom pointing toward resident/patient's head.
- 2) The spreader bar should then be hanging over re-sident/patient's chest and the resident/patient legs to one side of the base of lift (see Fig. 19).

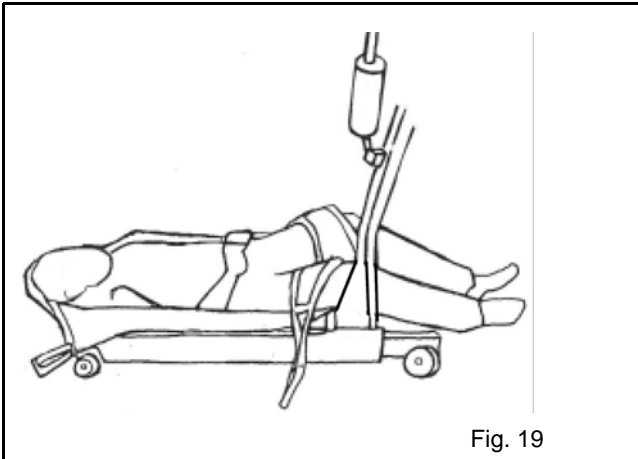

Fig. 19

- 3) Lower spreader bar as low as possible, close to chest area.
- 4) Take leg strap on left side of resident/patient, cross it diagonally in front of resident/patient, and attach it to the right hand suspension hook, i.e. to "opposite" hook. Repeat procedure for left leg strap. The suspended leg straps should now be crossed in front of resident/patient.
- 5) Attach the long right strap to the right spreader bar hook, which is next to the resident/patient's head. Repeat procedure for left leg strap. Make sure to use matching loops on both sides to ensure that the resident/patient will be evenly suspended.
- 6) The residents/patients arms remain inside the sling at all times.
- 7) Make sure the loops of the sling are securely fastened to the spreader bar and fully inside the safety latches.
- 8) The resident/patient can now be lifted. Raise the lift until resident/patient is almost clearing the floor and smooth out any "bunching" under the body to improve comfort (see Fig. 20).

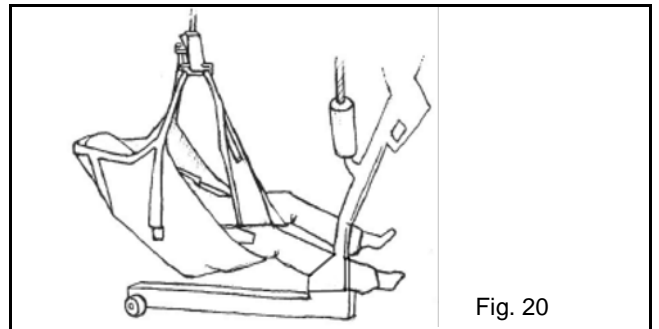

Fig. 20

- 9) Continue raising resident/patient until feet can clear the base of lift. If appropriate, turn resident/patient in direction of travel (See Fig. 21).
- 10) Lower boom to a suitable height for transferring.
- 11) If resident/patient needs steadying while being transferred, hold one of side handles on sling but take care not to push or pull resident/patient with the sling handles.

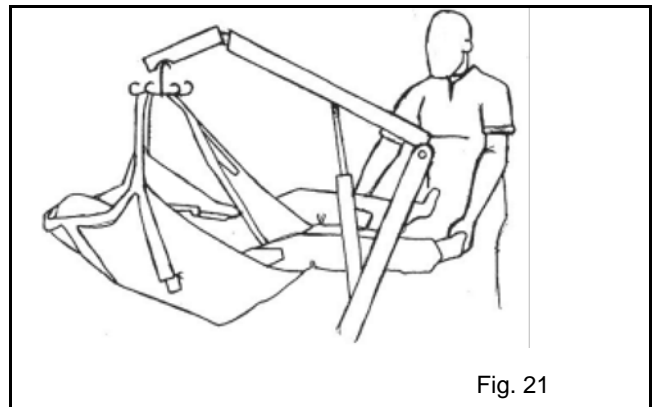

Fig. 21

Limb Sling

Description

This sling is especially designed for use with ArjoHuntleigh floor lifts and ceiling lifts. Easy to use, the limb sling supports the resident/patient's limb without any help of the caregiver. It also provides an easy access to the resident/patient's lower limbs for dressing and hygienic cares.

Limb Sling

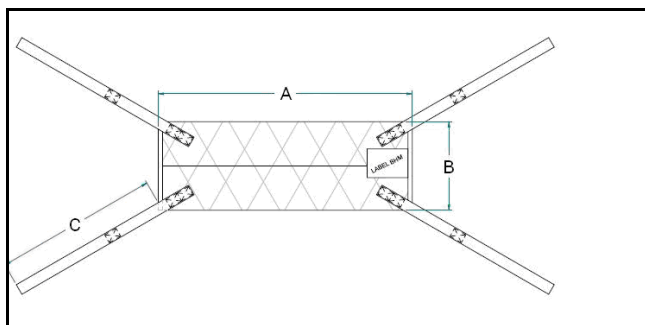

Part number and model

300.20005 - Limb sling

A: 58.5 cm/23 in

B: 20.5 cm/8 in

C: 38 cm /15 in

Sling Application

- 1) Place the sling under the resident/patient's limb.
- 2) Fix the sling to a hook spreader bar.
- 3) Lift up the resident/patient's limb to the desired level.

Features - Limb Sling

Features of Limb Sling

Characteristics	Benefits
Padded and quilted polyester fabric	Specially designed fabric is ultra-soft, long lasting and provides extra comfort for the resident/patient.
Strong nylon straps with positioning loops	Resident/patient's position can be adjusted slightly depending on need. Provides flexibility for comfort.
136 kg (300 lb) safe working load	Very strong and durable. Ensures resident/patient's safety.
Machine washable	Easy to clean and care for.
One size	Fits 95% of residents/patients.

Hammock and Hammock 6 Slings

Description

The Hammock and Hammock 6 are total lift slings designed for use with ArjoHuntleigh loop-style ceiling and floor lifts. The sling provides full head and neck support and double thigh padding for comfort.

There is a six strap option for safety or for use with non-cooperative/agitated residents/patients. This sling is made of a quick drying mesh fabric. That makes it ideal for bathing as well as general transfers.

Hammock Sling

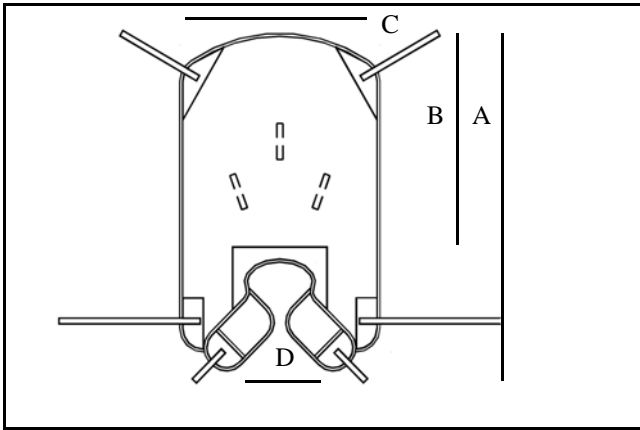

Part number and model

THAI-S- small Hammock sling (recommended for users 20 to 45 kg / 45 to 100 lb)

A: 106 cm/42 in
B: 76 cm/30 in
C: 66 cm/26 in
D: 23 cm/ 9 in

THAI-M- medium Hammock sling (recommended for users 45 to 90 kg / 100 to 200 lb)

A: 125 cm/49 in
B: 94 cm/37 in
C: 86 cm/34 in
D: 28 cm/11 in

THAI-L- large Hammock sling (recommended for users 90 to 272 kg / 200 to 600 lb)

A: 145 cm/57 in
B: 106 cm/42 in
C: 97 cm/38 in
D: 28 cm/11 in

Hammock 6 Sling

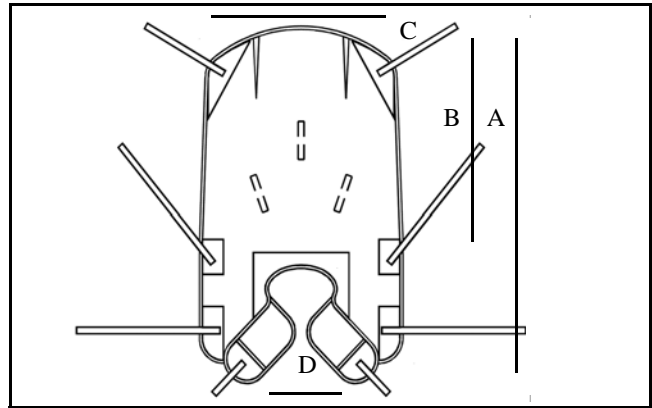

Part number and model

THA6I-S - small Hammock 6 sling (recommended for users 20 to 45 kg / 45 to 100 lb)

A: 106 cm/42 in
B: 76 cm/30 in
C: 66 cm/26 in
D: 23 cm/ 9 in

THA6I-M - medium Hammock 6 sling (recommended for users 45 to 90 kg / 100 to 200 lb)

A: 125 cm/49 in
B: 94 cm/37 in
C: 86 cm/34 in
D: 28 cm/11 in

THA6I-L - large Hammock 6 sling (recommended for users 90 to 272 kg / 200 to 600 lb)

A: 145 cm/57 in
B: 106 cm/42 in
C: 97 cm/38 in
D: 28 cm/11 in

Sling Position

Seated position

- 1) Align centre of sling with resident/patient's spine. Base of sling (top of the "arch") must be at the coccyx.

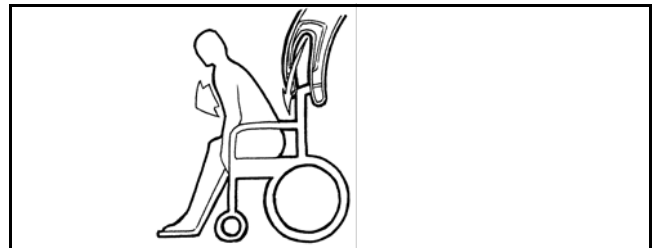

Hammock and Hammock 6 Slings

Supine Position

- 1) Log roll resident/patient and fan fold sling aligning centre of sling with resident/patient's spine. Base of sling (top of the "arch") must be at the base of the spine (coccyx).

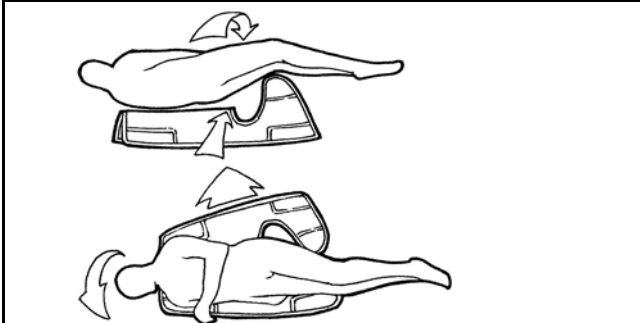

- 2) Pull short straps over the hips and under thighs.

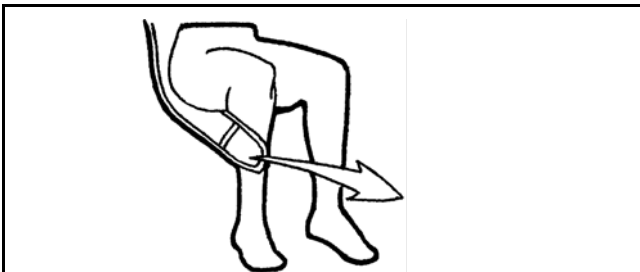

- 3) Cross straps inside each other.

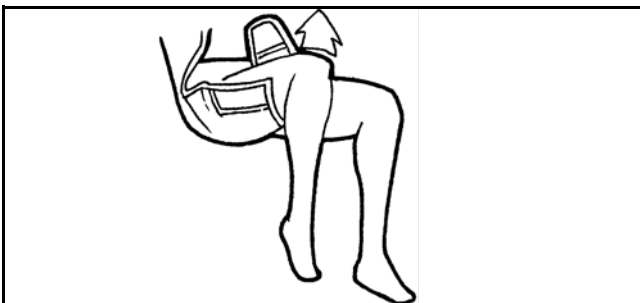

- 4) Feed the long straps through the short to form a bridge over resident/patient's legs (See option 1).

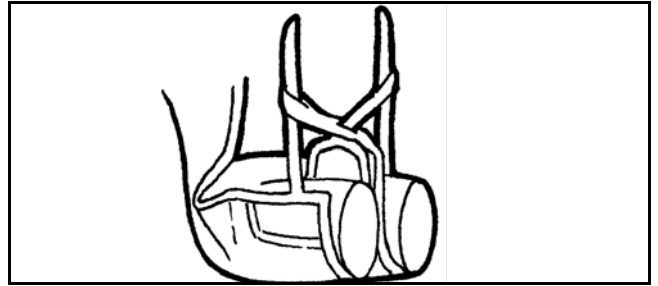



OPTION 1

Safest most compatible for residents/patients and recommended for most general transfers.



**OPTION 2 -
Legs opened**

This method pulls the resident/patient's legs apart - do not use in the case of fragile or replaced hips. Suitable for hygiene if indicated.

Not for all residents/patients.



**OPTION 3 -
Amputee**

Not indicated for agitated or spastic users. Can provide a comfortable cradle for below the knee amputees.

Features - Hammock Slings

Features of Hammock Sling

Characteristics	Benefits
Soft polyester net	Specially designed fabric is ultra-soft, long lasting and dries quickly (excellent for bath transfers). Gently “hugs” resident/patient. Fabric is easy to move, easy to install in bed.
Ultra smooth nylon/polyester leg area	Easy to install on a seated resident/patient. Resident/patient never has to sit on the sling. Slides without irritation to resident/patient’s skin.
Strong nylon/polyester straps with positioning loops	Resident/patient can be seated, semi-reclined and fully reclined during transfers. Provides flexibility for many types of residents/patients.
Weight-distribution inserts	Distributes the weight evenly throughout the sling, no pinching or pressure points.
Special leg strap design	Ensures the security of the resident/patient, even with agitated residents/patients. Extremely mobile residents/patients cannot fall out. Leg can be positioned.
Head support	Excellent for most general transfers. Suitable for 80% of residents/patients. Ensures that the resident/patient is fully supported.
Positioning handles	Residents/patients can be transferred to any position from any position. Positions resident/patient properly in the chair, no second adjustment needed. Transferring from lying position to seated position fast and easy. Provides a safe place for caregiver to turn the resident/patient.
272 kg (600 lb) safe working load	Very strong and durable. Ensures patient safety.
Single solid piece construction	No skin irritation from seams. Increases sling strength and safety.
Machine washable	Easy to clean and care for.
S, M, L Sizes	Medium fits most residents/patients. Small sizes fit most paediatric patients, large fits tall residents/patients.

Hammock 6 Strap Additional Features

Characteristics	Benefits
Additional straps at the hips	Provides a more secure feeling for the resident/patient. Prevents low-tone residents/patients from leaning to the side. May be suitable for transferring orthopaedic residents/patients.
Tightened head support	Provides additional support for the head. Sling gently supports more of the upper body.

Hygienic Sling

Description

This is a total lift toileting sling designed for use with ArjoHuntleigh ceiling and floor lifts. It allows care providers to remove clothes from residents/patients without removing the sling. The sling is constructed using less material and is therefore easier to put on and remove.

It has a buckle type of harness. To use the sling, the resident/patient must have good upper body and head control plus sitting ability. The residents/patients arms are positioned outside the sling at all times.

Hygienic Sling

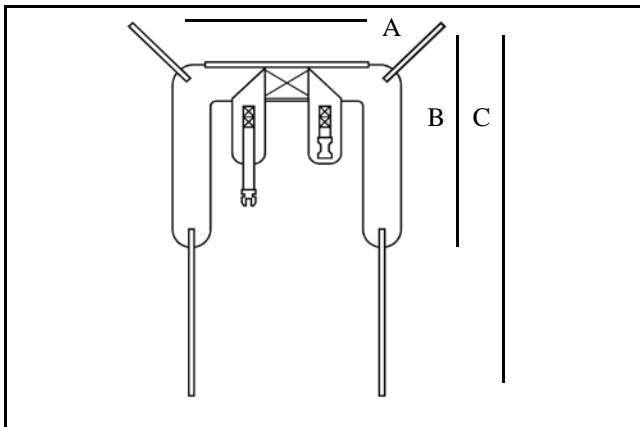

Part number and model

THY-S - small hygienic sling (recommended for users chest 69-89 cm / 27 and 35 in)

A: 97 cm/38 in

B: 84 cm/33 in

C: 152 cm/60 in

THY-M - medium hygienic sling (recommended for users chest 89-107 cm / 35 and 42 in)

A: 107 cm/42 in

B: 89 cm/35 in

C: 157 cm/62 in

THY-L - large hygienic sling (recommended for users chest 107-125 cm / 42 and 49 in)

A: 117 cm/46 in

B: 94 cm/37 in

C: 162 cm/64 in

Sling Application

Seated position

- 1) Align centre of sling with resident/patient's spine. Top of sling (foam padding) should be placed just under the shoulder blades, or halfway down the resident/patient's back.

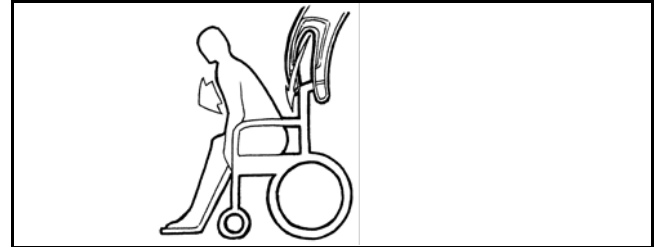

- 2) The leg section should be placed near the resident/patient's groin area and his or her arms must be outside the sling to avoid the resident/patient slipping through the sling.

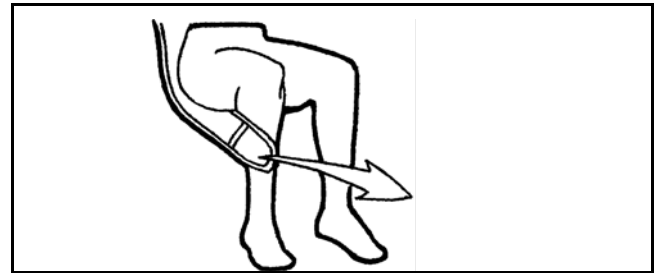

- 3) The hygienic sling is ideal for transferring to the toilet. It also provides an easy way to change incontinence pads.

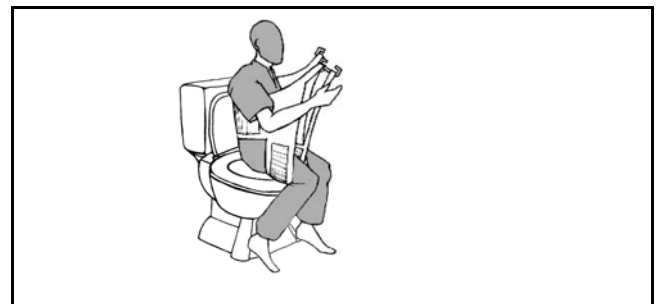

Features - Hygienic Sling

Resident/patient's position using strap colour combination

	Shoulders	Legs
		
	Blue	Blue
	Grey	Grey
	Black	Black

Features of Hygienic Sling

Characteristics	Benefits
Open area from above waist to thighs.	Excellent for toileting. Allows easy access to undergarments, incontinence pads or for cleaning. Sling supports both the upper body and lower body.
Padded and quilted polyester	Specially designed fabric is ultra-soft and long lasting. Sling provides extra comfort for the patient.
Padded waist band with belt	Easy to install on a seated resident/patient. Extra padding under the arms keeps the resident/patient comfortable during the transfer. Padding around entire waist reduces pressure.
Strong nylon/polyester straps with positioning loops	Resident/patient can be seated, semi-reclined or fully reclined. Legs can be raised or lowered slightly.
Special leg strap design	Leg straps are fully padded to reduce pressure. Legs can be positioned together, semi-open and fully open.
Positioning handles	Residents/patients can be transferred to any position from any position. Positions resident/patient properly in the chair with no second adjustment needed. Transferring from lying position to seated position fast and easy. The caregiver can pivot safely the resident/patient with the handle.
272 kg (600 lb) safe working load	Very strong and durable, ensures resident/patient safety.
S, M, L Sizes	Medium fits most residents/patients. Small sizes fit most paediatric residents/patients, large sizes fit tall residents/patients.
Machine washable	Easy to clean and care for.

Quick Fit Sling

Description

This is a general purpose total lift sling, designed for use with ArjoHuntleigh ceiling and floor lifts. It is used to lift residents/patients from the bed, wheel chair, geriatric chair, toilet, shower chair and off the floor. This sling can be used for residents/patients with limited upper body function, but they must have good head control because the sling does not provide head support. The Quick Fit design makes it perfect for stocky or obese residents/patients with large hips or thighs. The residents/patients arms remain inside the sling at all times.

Quick Fit Sling

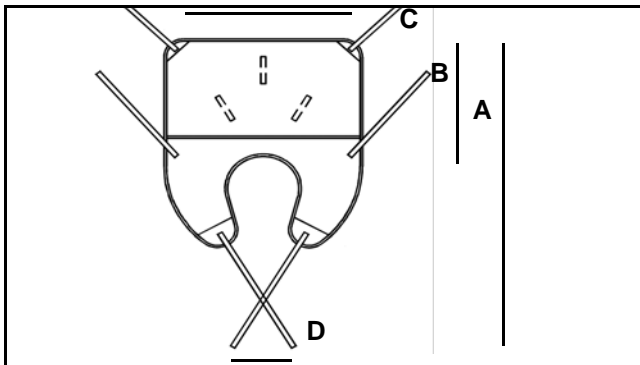

Part number and model

TIR-S - small Quick Fit sling (recommended for users 20 to 45 kg / 45 to 100 lb)

A: 102 cm/40 in
B: 56 cm/22 in
C: 89 cm/35 in
D: 31 cm/12 in

TIR-M - medium Quick Fit sling (recommended for users 45 to 90 kg / 100 to 200 lb)

A: 117 cm/46 in
B: 66cm/26 in
C: 99 cm/42 in
D: 36 cm/14 in

TIR-L - large Quick Fit sling (recommended for users 90 to 272 kg / 200 to 600 lb)

A: 127 cm/50 in
B: 71 cm/28 in
C: 109 cm/43 in
D: 37 cm/14 in

Sling Application

Seated position

- 1) Align centre of sling with resident/patient's spine. Base of sling (top of the "arch") must be at the coccyx.

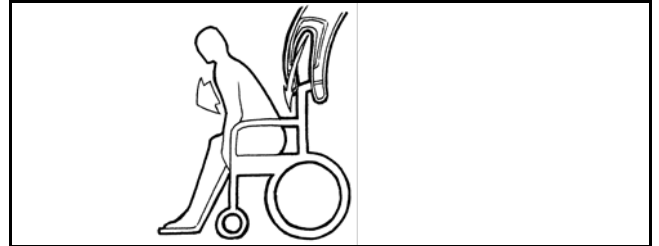

Supine position

- 1) Log roll patient/resident and fan fold sling aligning centre of sling with patients spine. Base of sling (top of the "arch") must be at the coccyx.

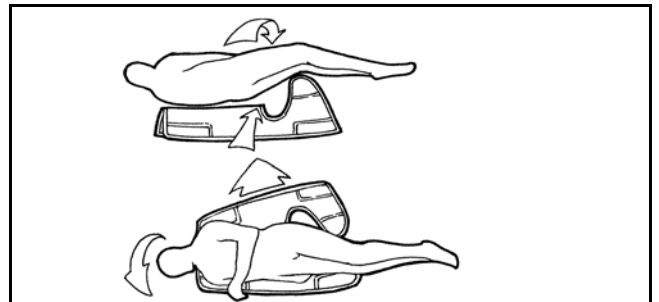

- 2) Pull short strap over hips and under thighs.

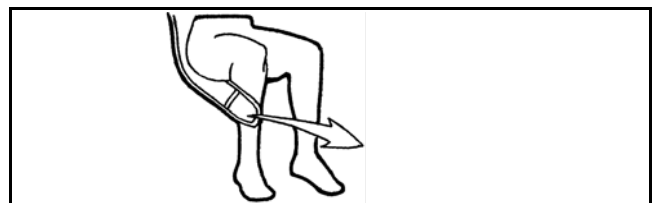



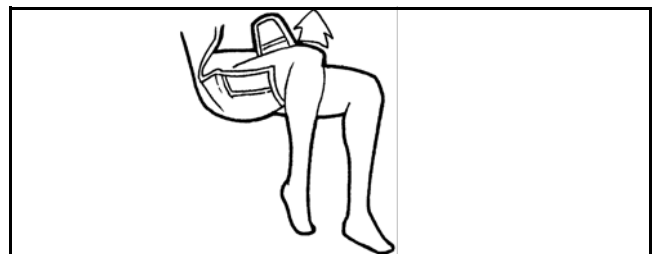

- 3) Cross straps inside each other. An opening is provided for this at the base of the leg strap



Features - Quick-Fit Sling

Resident/
patient
using strap
colour
combination

	Shoulders	Legs
		
	Black	Blue
	Grey	Blue
	Blue	Blue
	Blue	Grey



OPTION 1 BRIDGE

Safest most compatible for user. Recommended for most general transfers.



OPTION 2 AMPUTEE

Not indicated for agitated or spatic users. Can provide a comfortable cradle for below the knee of amputees.

Features of Quick-Fit Sling

Characteristics	Benefits
Soft polyester net upper	Specially designed fabric is ultra-soft and long lasting. Fabric is easy to move and easy to install in bed.
Soft nylon/polyester padded leg area	Easy to install on a seated resident/patient. Residents/patients never have to sit on the sling. Slides without irritation to the resident/patient's skin.
Strong nylon/polyester straps with positioning loops	Resident/patient can be seated and semi-reclined. Provides flexibility for many types of residents/patients.
Special leg strap design	Ensure the security of the resident/patient, even with agitated residents/patients. Legs can be positioned together, semi-open and open.
Extra sturdy	Excellent for obese and stocky residents/patients. Adjustable straps to position slings. Extra room for thighs and hips. Has hip strap to support weight on the sides.
Positioning handles	Residents/patients can be transferred to any position from any position. Position resident/patient properly in the chair. No second adjustment needed. Transferring from lying position to seated position fast and easy. Provides a safe place for caregiver to turn the resident/patient.
272 kg (600 lb) safe working load	Very strong and durable. Ensures resident/patient's safety.
S, M, L Sizes	Medium fits most residents/patients. Small sizes fit most paediatric residents/patients and large fit tall residents/patients.
Machine washable	Easy to clean and care for.

Band Sling and Chest Harness

Description

The Band Sling and the Chest Harness have a wide body component for increased support of the upper thorax; minimizing the sling “riding up” under the arms of the resident/patient. Designed for use with ArjoHuntleigh sit/stand floor lifts, these slings are to be used for seat to seat transfers, toileting and peri care.

The slings allow for removal of lower extremity clothes of residents/patients without removal of sling. The Band Sling and the Chest Harness can also be used for practice weight bearing and balance for partially dependant residents/patients. Residents/patients should have good upper body control to hold themselves up and lean back. The residents/patients's arms are positioned outside the sling at all times.

Band Sling

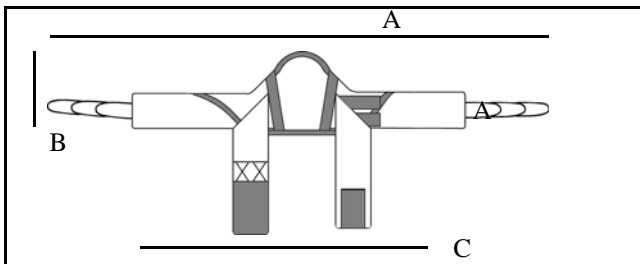

Part number and model

TST-S - small Padded Band Sling (recommended for users 20 to 45 kg / 45 to 100 lb)

A: 150 cm/59 in
B: 31 cm/12 in
C: 109 cm/43 in

TST-M - medium Padded Band Sling (recommended for users 45 to 90 kg / 100 to 200 lb)

A: 150 cm/59 in
B: 33 cm/13 in
C: 122 cm/48 in

TST-L - large Padded Band Sling (recommended for users 90 to 180 kg / 200 to 400 lb)

A: 158 cm/62 in
B: 37 cm/14 in
C: 145 cm/57 in

TST-XL - Xlarge Padded Band Sling (recommended for users 180 to 200 kg / 400 to 440 lb)

A: 163 cm/64 in
B: 38 cm/15 in
C: 168 cm/66 in

Chest Harness

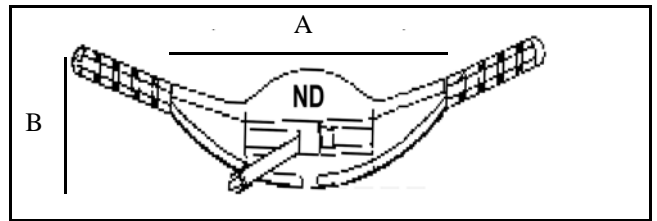

Part number and model

4001 C- Chest harness non-slip CHILD (recommended for users 20 to 68 kg / 45 to 150 lb)

A: 96 cm/38 in
B: 23 cm/9 in

4001 - Chest harness non-slip (recommended for users 68 to 272 kg / 150 to 600 lb)

A: 106 cm/42 in
B: 33 cm/13 in

Sling application

Seated position

- 1) From in front of resident/patient, leans resident/patient forward and positions sling around the lower back. Connect safety buckle together and pull snug to fit around abdomen area.

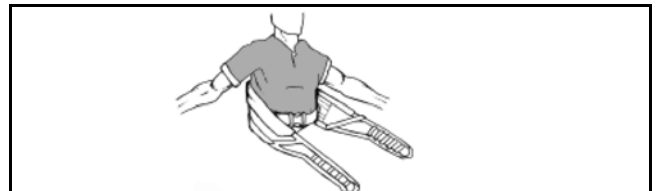

- 2) Connect appropriate loop strap to hook on the boom of lift on both sides. Make sure strap has no “play” in it. To stand resident/patient, ask resident/patient to lean back and press the UP button on lift.



- 3) Band Sling / Chest Harness is used with lift for toileting.

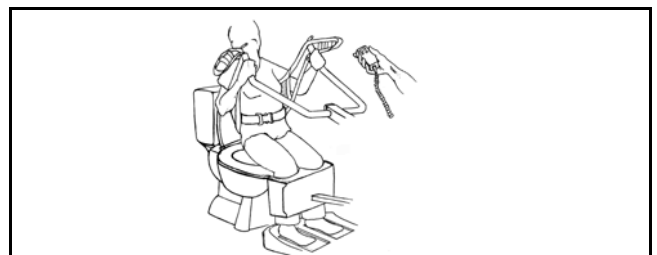

Features - Band Sling and Chest Harness

Features of Band Sling

Characteristics	Benefits
Velcro and double belted waist band	Velcro closure adjusts to different sizes. Double belted waist band secures resident/patient in sling. Enables resident/patient to stand with the security of knowing they are fully supported. Easy to install on a seated resident/patient.
Padded and quilted nylon/polyester	Specially designed fabric is ultra-soft, long lasting and provides extra comfort for the resident/patient. Fabric is easy to move.
Extra padding under arms	Provides additional cushion for the resident/patient. Flexible and gentle.
PVC netting	Sure-grip material keeps the sling in place. Soft material is gentle to skin.
Back support strips	Distributes the weight evenly throughout the sling. Covers a wide area of the back for support. Reduces pressure under the arms.
Strong nylon/polyester straps with positioning loops	Adjustable straps allow for residents/patients with a large midsection. Provides flexibility for many types of residents/patients.
200 kg (440 lb) safe working load	Very strong and durable. Ensures resident/patient safety.
S, M, L, XL Sizes	Medium fits most residents/patients. Small sizes fit most paediatric residents/patients. Large and XLarge fits tall or very stocky residents/patients.
Machine washable	Easy to clean and care for.

Total Transfer Harness

Description

The Total Transfer Harness has a wide body component for increased support of the upper thorax; minimizing the harness “riding up” under the arms of the resident/patient. Designed for use with ArjoHuntleigh sit/stand floor lifts. This sling is to be used for seat to seat transfers, toileting and peri care.

This harness allows removal of lower extremity clothes of residents/patients without removing the harness. Residents/patients should have good upper body control to hold themselves up and lean back. The added leg straps provide additional support under hamstring area. The resident/patient arms are positioned outside the sling at all times.

Total Transfer Harness

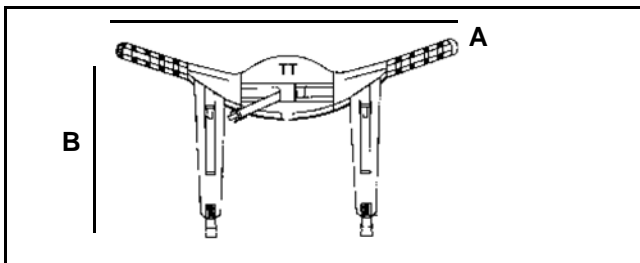

Part number and model

4000TTC- Total Transfer for children
(recommended for users 20 to 68 kg / 45 to 150 lb)

A: 106 cm/42 in
B: 61 cm/24 in

4000TT- Total Transfer for adults (recommended
for users 68 to 200 kg / 150 to 440 lb)

A: 117 cm/46 in
B: 71 cm/28 in

Harness Application

- 1) From in front of resident/patient, caregiver leans resident/patient forward and positions harness around the lower back. Connect safety buckle together and pull snug to fit around abdomen area.

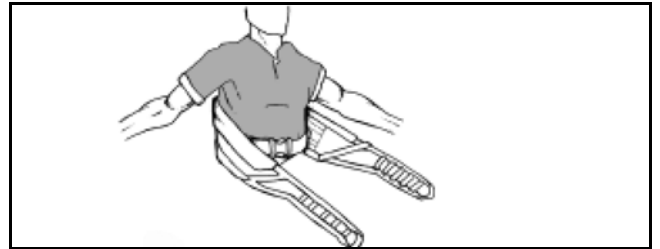

- 2) Prior to connecting the straps to the lift, pull the padded leg support over the hips, and under the leg from the outside to the inside of the leg and connect to the buckle. Repeat for the other leg. Do not tighten leg straps while resident/patient is seated.

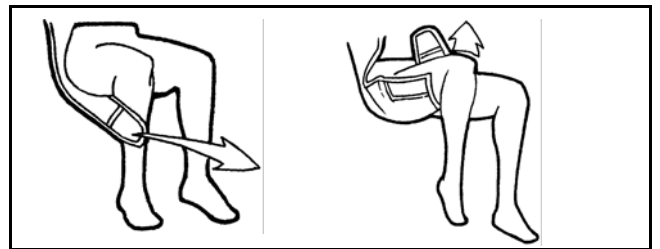

- 3) Connect appropriate loop strap to hook on the boom of lift on both sides. Make sure strap has no “play” in it. To stand resident/patient, ask resident/patient to lean back and press the UP button on lift.

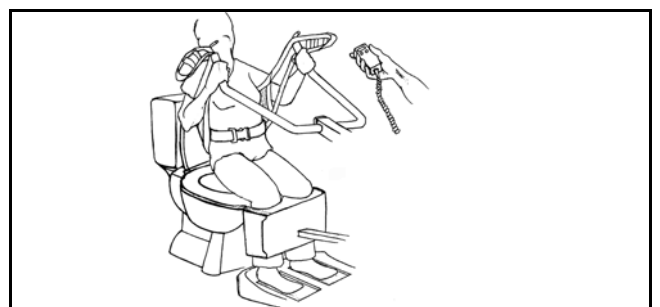

Features - Total Transfer Harness

Features of Total Transfer Harness

Characteristics	Benefits
Belted waist band	Belted waist band secures resident/patient in sling. Enables resident/patient to stand with the security of knowing they are fully supported. Easy to install on a seated resident/patient.
Extra padding under arms	Provides additional cushion for the resident/patient. Flexible and gentle.
Back support strips	Distributes the weight evenly throughout the sling. Covers a wide area of the back for support. Reduces pressure under the arms.
Strong nylon/polyester straps with positioning loops	Adjustable straps allow for residents/patients with a large midsection. Provides flexibility for many types of residents/patients.
200 kg (440 lb) safe working load	Very strong and durable. Ensures resident/patient safety.
Machine washable	Easy to clean and care for.

Combi Sling

Description

This is a high-back sling and is designed for use with ArjoHuntleigh loop-style ceiling or floor lifts. Integral head support is incorporated into the sling design. This sling supports the whole body including the head. It is particularly suitable for residents/patients with little control over their head and body. This sling will position the resident/patient in the most upright sitting position possible. The residents/patients arms remain inside the sling at all times.

Combi Sling

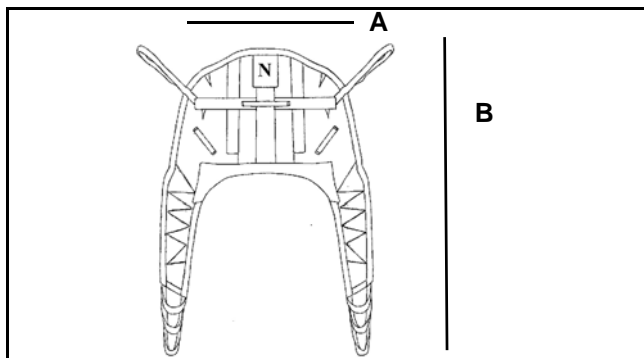

Part number and model

The 626002C Combi Sling Deluxe Child and the 626002C-M Combi Sling Mesh Deluxe Child models are recommended for users 20 to 68 kg / 45 to 150 lb

A: 81 cm/32 in
B: 137 cm/54 in

The 626002 and 626002M models are recommended for users 68 to 272 kg / 150 to 600 lb

A: 91 cm/36 in
B: 152 cm/60 in

Sling Application

Seated position

- 1) Align centre of sling with patient's spine. Base of sling (top of the "arch") must be at the coccyx.

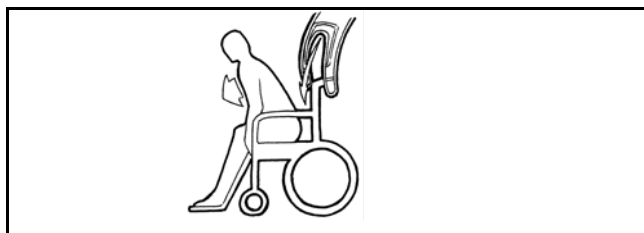

Supine Position

- 1) Log roll resident/patient and fan fold sling aligning centre of sling with patients' spine.

Base of sling (top of the "arch") must be at the coccyx.

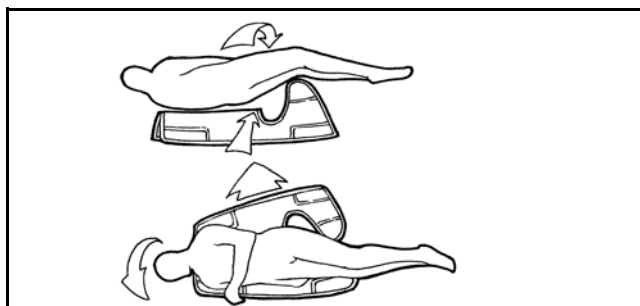

- 2) Pull straps forward and under (between) thighs. Cross straps through each other.

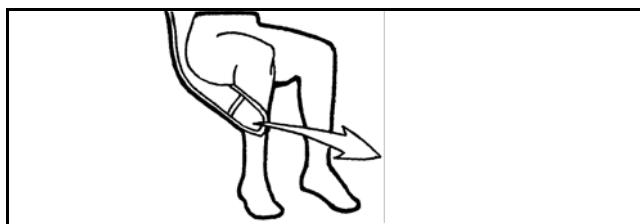

- 3) Cross long straps through short straps to form a bridge above the resident/patient's legs (see option 1 on the following page).

Resident/patient's position using strap colour combination

	Shoulders	Legs
	Yellow	White
	Green	White
	White	Black
	White	Orange

Features - Combi Sling



OPTION 1 - BRIDGE

Safest most compatible for resident/patient. Recommended for most general transfers.



OPTION 2 - LEGS SEPARATION

This method pulls the resident/patient's legs apart – do not use in the case of fragile or replaced hips. Suitable for hygiene if indicated.



OPTION 3 - AMPUTEE

Not indicated for agitated or spastic users. Can provide a comfortable cradle for below the knee amputees.



Features of Combi sling

Characteristics	Benefits
Soft polyester net	Specially designed fabric is ultra-soft, long lasting and dries quickly. Fabric is easy to move, easy to install in bed.
Strong nylon/polyester straps with positioning loops	Resident/patient can be seated, semi-reclined and fully reclined during transfer. Provides flexibility for many types of patients.
Special leg strap design	Ensures the security of the resident/patient. Extremely mobile residents/patients cannot fall out. Legs can be positioned.
Weight-distribution inserts	Distributes the weight evenly throughout the sling, no pinching or pressure points.
Head support	Excellent for most general transfers. Suitable for 80% of residents/patients. Ensures that the resident/patient is fully supported.
272 kg (600 lb) safe working load	Very strong and durable. Ensures resident/patient's safety.
Machine washable	Easy to clean and care for.

Repositioning Sling

Description

This sling is designed to reduce the risk of injury to caregivers by assisting with resident/patient positioning and adjustments in bed. The sling is placed in bed as part of the bedding and the straps allow the caregiver to easily lift the resident/patient just enough to reposition and lower.

The polyester net material breathes easily, is soft to touch and can be left under the resident/patient. Loops on the straps near the head provide adjustment for head position. This sling may also be used for lateral transfers, and is designed for use with ArjoHuntleigh ceiling and floor lifts. The resident/patient's arms remain inside the sling at all times.

Repositioning Sling

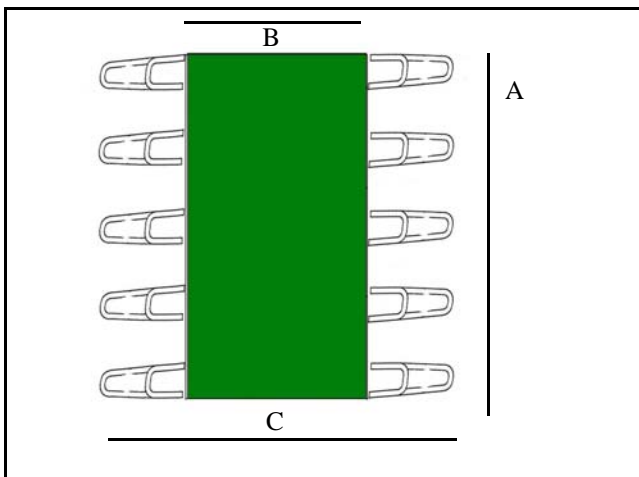

Part number and model

624500 - Repositioning sling

A: 180 cm/71 in

B: 90 cm/35.5 in

C: 190.5 cm / 75 in

Sling Application

Supine Position

Align centre of sling with resident/patient's spine.

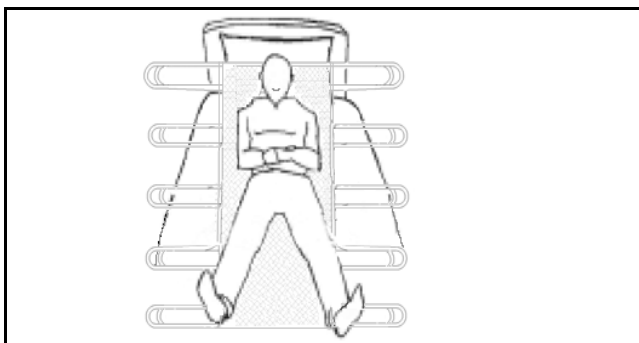

Features - Repositioning Sling

Features of Repositioning Sling

Characteristics	Benefits
Soft polyester net	Specially designed fabric is ultra-soft and long lasting. Fabric is easy to move, easy to install in bed.
Strong nylon/polyester straps with positioning loops	Resident/patient's position can be adjusted slightly depending on need. Provides flexibility for comfort. Excellent for heavy residents/patients. Extra room for thighs.
Extra sturdy	Excellent for heavy residents/patients. Extra room for thighs and hips.
272 kg (600 lb) safe working load	Very strong and durable. Ensures resident/patient's safety.
Machine washable	Easy to clean and care for.
One size	Fits 95% of residents/patients.

Morgue Transfer Device

Description

The morgue transfer device consists of the morgue spreader bar and body bands. The spreader bar is made of stainless steel and has multiple positioning points. The body bands are fluid resistant and can be easily cleaned.

The body bands also have multiple connection points ensuring a safe transfer. Can be used with all ArjoHuntleigh lifts however works better with ArjoHuntleigh ceiling lifts.

Morgue Transfer Device

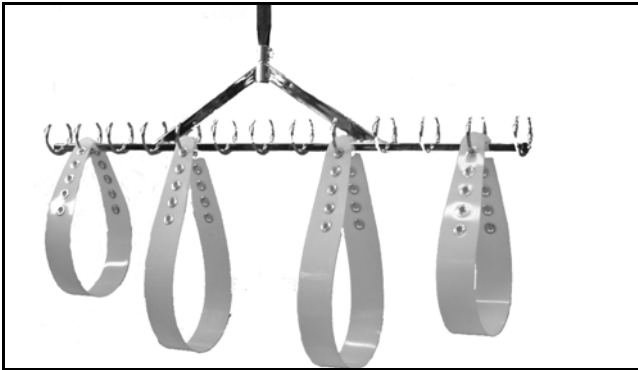

Part number and model

700.05380 - Standard Kit includes spreader bar and

2 - 47" & 2 - 57" body bands

700.05385 - Bariatric Standard Kit includes spreader bar and 2 - 47" & 2 - 72" body bands

700.05390 - Standard kit includes 2 - 47" & 2 - 57" body bands

700.05395 - Bariatric Standard Kit includes spreader bar and 2 - 47" & 2 - 72" body bands

Sling Application



Features - Morgue Transfer Device

Features of Morgue Transfer Device

Characteristics	Benefits
Multiple positioning points	Both support bar and body bands have multiple positioning points to ensure a safe transfer.
Stainless steel support bar	Frame is rust resistant so can be submerged in water.
272 kg (600 lb) safe working load	Very strong and durable. Ensures safety.
Machine washable	Easy to clean and care for.

Walking Sling

Description

These slings help to hold residents/patients in a standing position. For gait training, balance and to protect caregivers or rehab nurses. During walking exercises, it can provide complete or partial support. Users must have some weight bearing ability.

The Walking Slings fits all ArjoHuntleigh ceiling lift models. Do not use either of these slings on a resident/patient who does not have weight bearing ability and good muscle tone in their shoulders and neck.

Walking Sling

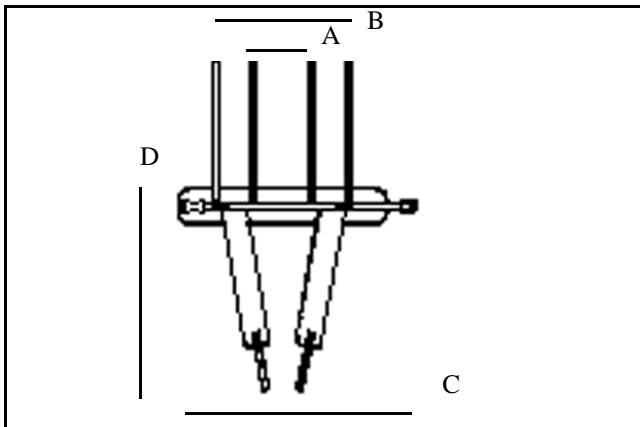

Part number and model

TEM-S - small Walking Sling (recommended for users 20 to 45 kg / 45 to 100 lb)

A: 25 cm/10 in
B: 50 cm/20 in
C: 89 cm/35 in
D: 76 cm/ 30 in

TEM-M - medium Walking Sling (recommended for users 45 to 90 kg / 100 to 200 lb)

A: 30 cm/12 in
B: 68 cm/27 in
C: 106 cm/42 in
D: 91 cm/36 in

TEM-L - large Walking Sling (recommended for users 90 to 200 kg / 200 to 440 lb)

A: 30 cm/12 in
B: 86 cm/34 in
C: 124 cm/49 in
D: 112 cm/44 in

Applying the Walking Sling

- 1) Place white fabric next to the resident/patient. Labels and outside straps are on the outside.
- 2) Lean patient forward in the chair and make sure the patient is supported.

- 3) Place the sling around user's chest area, clip belt and snug tightly with belt strap.
- 4) Two legs sections will extend down each side. Slide panels under left and right leg.
- 5) Thread right chest strap through right leg strap. Thread left chest strap through left leg strap.
- 6) Arms will always be between chest straps and back straps.
- 7) Adjust the sling loops higher or lower in either the front or the back to tilt the body in either direction to correct posture.
- 8) Always use the same colour loop on the rear shoulder straps for both sides. Use the same colour loop on the chest straps for both sides.
- 9) Ensure sling is not caught on any obstructions (e.g. wheelchair brake or handle). Make sure the sling sections between the legs are providing snug support. If not, reinstall the sling threading the chest straps through a lower loop (grey or black).

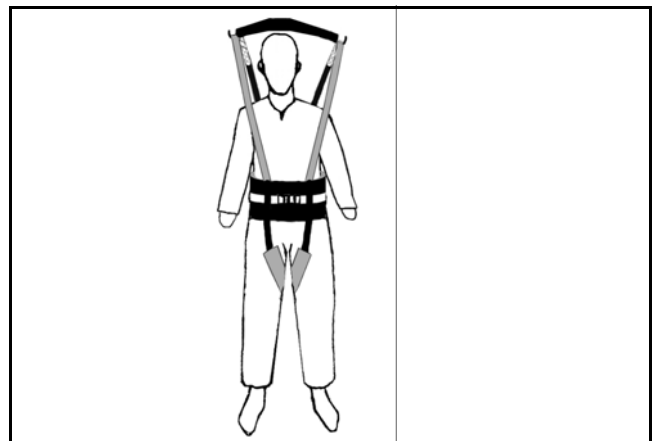

Features - Walking Sling

Features of Walking Sling

Characteristics	Benefits
Waist band and leg straps	Excellent for rehab uses. Narrow, padded strap support through the legs. Enables resident/patient to walk with the security of knowing they are fully supported.
Padded and quilted polyester	Specially designed fabric is ultra-soft, long lasting. Provides extra comfort for the resident/patient. Fabric is easy to move.
Padded waist band with belt	Easy to install on a seated patient. Padding around entire waist reduces pressure.
Strong nylon/polyester straps with positioning loops	Resident/patient can be positioned forward, straight or slightly backward. Adjustable straps allow for residents/patients with a large midsection. Provides flexibility for many types of residents/patients.
Special leg strap design	Leg straps are fully padded to reduce pressure. Straps are adjustable to patient size.
Walking Sling : 200 kg (440 lb) safe working load	Very strong and durable. Ensures resident/patient's safety.
Machine washable	Easy to clean and care for.

AUSTRALIA

ArjoHuntleigh Pty Ltd
78, Forsyth street
O'Connor
AU-6163 Western Australia
Tel: +61 89337 4111
Free: +1 800 072 040
Fax: + 61 89337 9077

BELGIQUE / BELGIË

ArjoHuntleigh NV/SA
Evenbroekveld 16
B-9420 ERPE-MERE
Tél/Tel: +32 (0) 53 60 73 80
Fax: +32 (0) 53 60 73 81
E-mail: info@arjohuntleigh.be

CANADA

ArjoHuntleigh Canada Inc.
1575 South Gateway Road
Unit "C"
MISSISSAUGA, ON, L4W 5J1
Tel/Tél: +1 905 238 7880
Free: +1 800 665 4831 Institutional
Free: +1 800 868 0441 Home Care
Fax: +1 905 238 7881
E-mail: info.canada@arjohuntleigh.com

ČESKÁ REPUBLIKA

ArjoHuntleigh s.r.o.
Hlinky 118
CZ- 603 00 BRNO
Tel: +420 549 254 252
Fax: +420 541 213 550

DANMARK

ArjoHuntleigh A/S
Vassingerødvej 52
DK-3540 LYNGE
Tel: +45 49 13 84 86
Fax: +45 49 13 84 87
E-mail: info.dk@arjohuntleigh.com

DEUTSCHLAND

ArjoHuntleigh GmbH
Peter-Sander-Strasse 10
D-55252 MAINZ-KASTEL
Tel: +49 (0) 6134 186 0
Fax: +49 (0) 6134 186 160
E-mail: info-de@arjohuntleigh.com

ΕΛΛΑΔΑ

C. Psimitis Co Ltd
Dimitriou Andr. 59
GR-16121 KAISARIANI ATTIKIS
Τηλ: 21 0724 36 68
Φάξ: 21 0721 55 53

ESPAÑA

ArjoHuntleigh Ibérica S.L.
Ctra. de Rubí, 88 1ª planta - A1
08173 Sant Cugat del Vallés
ES- BARCELONA 08173
Tel: +34 93 583 11 20
Fax: +34 93 583 11 22
E-mail: info.es@arjohuntleigh.com

FAR EAST

ARJO Far East Limited
Unit 3A, 4/F., block B Hoi Luen
Industrial Centre
55 Hoi Yuen Road,
Kwun Tong, Kowloon
HONG KONG
Tel: +852 2508 9553
Fax: +852 2508 1416

FRANCE

ArjoHuntleigh SAS
2 Avenue Alcide de Gasperi
CS 70133
59436 RONCQ CEDEX
Tél: +33 (0) 3 20 28 13 13
Fax: +33 (0) 3 20 28 13 14
E-mail : info.france@arjohuntleigh.com

INTERNATIONAL

ArjoHuntleigh International Ltd.
ArjoHuntleigh House
Houghton Hall Park
Houghton Regis
UK-DUNSTABLE LU5 5XF
Tel: +44 (0) 1582 745 800
Fax: +44 (0) 1582 745 866
E-mail:
international@ArjoHuntleigh.com

ITALIA

ArjoHuntleigh S.p.A.
Via di Tor Vergata 432
00133 ROMA - ITALIA
Tel: +39 (0) 6 87426211
Fax: +39 (0) 6 87426222
E-mail: Italy.promo@arjohuntleigh.com

NEDERLAND

ArjoHuntleigh Nederland BV
Biezenwei 21
4004 MB TIEL
Postbus 6116
4000 HC TIEL
Tel: +31 (0) 344 64 08 00
Fax: +31 (0) 344 64 08 85
E-mail: info.nl@arjohuntleigh.com

NEW ZEALAND

ArjoHuntleigh Ltd
41 Vestey Drive
Mount Wellington
AUCKLAND 1060
Tel: +64 (0) 9 573 5344
Free Call: 0800 000 151
Fax: +64 (0) 9 573 5384
E-mail: nz.info@ArjoHuntleigh.com

NORGE

ArjoHuntleigh Norway AS
Ryenstubben 2
NO-0679 OSLO
Tel: +47 22 08 00 50
Faks: +47 22 08 00 51
E-mail: no.kundeservice@arjohuntleigh.com

POLSKA

ArjoHuntleigh Polska Sp. z o.o.
ul. Ks Piotra Wawrzyniaka 2
PL 62-052 KOMORNIKI (Poznan)
Tel: +48 61 662 15 50
Fax: +48 61 662 15 90
E-mail: arjo@arjohuntleigh.com

PORTUGAL

ArjoHuntleigh em Portugal:
MAQUET Portugal, Lda. (Distribuidor Exclusivo)
Rua Poeta Bocage n.º 2 - 2G
1600-233 Lisboa, Portugal
Tel: +351 214 189 815
Fax: +351 214 177 413
E-mail: Portugal@arjohuntleigh.com

SUISSE / SCHWEIZ

ArjoHuntleigh AG
Fabrikstrasse 8
Postfach
4614 Hägendorf,
Tél/Tel: +41 (0) 61 337 97 77
Fax: +41 (0) 61 311 97 42

SUOMI

ArjoHuntleigh OY
Vanha Porvoontie 229
FI-01380 VANTAA
Puh: +358 9 4730 4320
Faksi: +358 9 4730 4999

SVERIGE

ARJO Scandinavia AB
Verkstadsvägen 5
Box 61
SE-241 21 ESLÖV
Tel: +46 (0) 10-335 45 00
Fax: +46 (0) 413-138 76
E-mail: kundservice@arjohuntleigh.com

UNITED KINGDOM

ArjoHuntleigh UK
ArjoHuntleigh House
Houghton Hall Park
Houghton Regis
UK-DUNSTABLE LU5 5XF
Tel: +44 (0) 1582 745 700
Fax: +44 (0) 1582 745 745
E-mail:
sales.admin@ArjoHuntleigh.com

USA

ArjoHuntleigh Inc.
2349 W Lake Street Suite 250
Addison, IL 60101
Tel: +1 630 307 2756
Free: +1 800 323 1245 Institutional
Free: +1 800 868 0441 Home Care
Fax: +1 630 307 6195
E-mail: us.info@ArjoHuntleigh.com

ÖSTERREICH

ArjoHuntleigh GmbH
Dörrstrasse 85
AT-6020 INNSBRUCK
Tel: +43 (0) 512 204 160 0
Fax: +43 (0) 512 204 160 75

ARJOHUNTLEIGH

GETINGE GROUP

GETINGE GROUP is a leading global provider of products and systems that contribute to quality enhancement and cost efficiency within healthcare and life sciences. We operate under the three brands of **ArjoHuntleigh**, **GETINGE** and **MAQUET**. **ArjoHuntleigh** focuses on patient mobility and wound management solutions. **GETINGE** provides solutions for infection control within healthcare and contamination prevention within life sciences. **MAQUET** specializes in solutions, therapies and products for surgical interventions and intensive care.

www.ArjoHuntleigh.com



ArjoHuntleigh AB
Verkstadsvägen 5
241 38 Eslöv
SWEDEN



0 0 1 . 0 3 6 8 0 . 3 3 . E N